

Produktgruppen	Seite	Produktgruppen	Seite
1 Stahlrohrwerkzeuge und Ganzstahlhämmer	9 - 12	14 Werkzeuge für Klempner, Spengler, Gold- / Silberschmiede und Uhrmacher	39 - 49
2 Schlosser-, Vorschlaghämmer und Fäustel	13 - 17	15 Messer und Klängen	49 - 51
3 Klauenhämmer	17 - 19	16 Zangen und Scheren	51 - 55
4 Werkzeuge für Schmiede und Hufschmiede	19 - 22	17 Kellen	55 - 56
5 Brechstangen	22 - 23	18 Mess- und Anreißwerkzeuge	56 - 58
6 Werkzeuge für Pflasterer, Maurer und Steinbearbeitung, Garten- und Landschaftsbau	24 - 28	19 Sägen und Sägeblätter	59 - 60
7 Werkzeuge für Polsterer, Dekorateur und Bodenleger	29 - 31	20 Bits und Zubehör	60 - 62
8 Nietenzieher und -köpfer, Körner usw.	31	21 Beile, Äxte und Hammertacker	62 - 63
9 Sonderwerkzeuge	32 - 33	22 Pinsel, Spachtel usw.	63 - 65
10 Schweißer-, Gussputz- u. Kesselsteinhämmer	33 - 34	23 Lederartikel, Werkzeugkoffer	65 - 67
11 Schonhämmer	34 - 37	24 Stiele und Keilhülsen	67 - 69
12 Werkzeuge für Zimmerer und Schreiner	37	25 Ausbeulwerkzeug	69 - 77
13 Spezialwerkzeuge für Dachdecker	37 - 39	26 Werbeartikel	77
		Numerische Übersicht	8

Bezeichnung	Seite	Bezeichnung	Seite	Bezeichnung	Seite	Bezeichnung	Seite
A		C		E		G	
Abbrechklinge	51	Chariereisen	24–25	Eschenstiel	69	Grabegabel / Spatengabel	28
Abbrechklingenmesser	50	Charierhammer	24			Grabeschaufel "Foxpoint"	28
Abreibzange	76	Ciselerhammer	46	F		Gripzange	54
ALPHA-Anreißgerät	57	COTTA-Anreißgerät	57	Falzaufbiegezange	48	Großamboss	72
Aluminium-Japansäge	60	Crimp-Systemzange	55	Falzhammer	44	Gummiaufsatz für Fäustel	15
Ambosshorn	20	D		Falzmeißel	47	Gummihammer	36
Ambossschroter	20	Dachdecker Bit-Check Kombi	60	Falzzange	48	Gussputzhammer	34
Andrückrolle	65	Dachdecker Bit-Check Pozidriv	60	Faserzement-Hand- und Lochschere	39		
Anreißhammer	31	Dachdecker Bit-Check TORX	61	Faserzement-Handschere	39	H	
Anreißschablone	57	Dachdecker-Nageleisen	38	Faust	42	Hakenklinge	50
Anschlagwinkel	56	Dachdeckersäge	59	Fäustel	15	Haken-Rillenfaust	40
Arbeitsschere	53	Dämmstoffklinge	51	Fäustel, DIN 6475	12, 15	Hallenser Randschaufel	28
Arbeitsständer	44	Dämmstoffmesser	51	Fäustel-Minenhammer	16	Hammerschlaufe	65
Ausbeul- und Gummihammer	71	Dämmstoffmesserscheide	66	Feder für Bleischere	52	Hammer-Tacker	63
Ausbeul-, Schlicht- u. Schweifhammer	70–71	Dämmstoffsäge	59	Ferroplex-Kombihammer	35	Handamboss	72–74
Ausbeulhammer	69–70	Dänische Dachkelle	55	Figurenlochscherer	52	Handbeil	62
Ausbeul-Planierhammer	72	Dänische Zungenkelle	55	Figurenschere	52	Handfaust	73–74
Ausbeul-Schlageisen	74	Deckhammer	36	Finny-Arbeitsschere	53	Handnietzange	53
Ausbeul-Werkzeug-Satz	76–77	Deckzange	47–48	Firstkelle	55	Handsäge	59
Ausbeulzange	76	Dengelamboss	33	Flachmaul-Schmiedezange	21	Hannoversche Dachkelle	55
Auspresspistole	64	Dengelhammer	32–33	Flachpinsel	64	Haubrücke	38
Ausschlichthammer	45	Dopp. Spann.- u. Polierhammer	45	Flachschaber	49	Hebel- und Ausbeuleisen	75
Automatikmesser	50	Doppelfalzeisen	44	Flaschenöffner-Hammer	77	Hebel-Eternit- und Schieferschere	39
Automatikmesser, selbstladend	50	Doppelschliffklinge	50	Fliesen- / Ziegelbohrer	65	Heftklammern	63
		Doppelter Ausbeulhammer	69	KERAMIK		High Tech Schrauben-Löser / Edelstahl-Protector	62
		Doppelter Schlichthammer	69	Fliesenlegerhammer	29	Holländer Schaufel	28
B		Dörperzange	22	Fournierhammer	37	Holsteiner Schaufel	28
Ballhammer-Oberteil	20	Dornzange	22	Frankfurter Schaufel	28	Holzgliedermaßstab "PICARD"	56
Ballhammer-Unterteil	20	Drainagespaten mit T-Griff	28	Fräserfeilenblatt	76	Holzhammer	34
Bankamboss	40	Dreikant-Hohlschaber	48	Fräserfeilenhalter	76	Holzspalthammer	32
Baseball-Cap "Picard"	77	Dreikant-Löffelschaber	49	Fruchtkistenhammer	33	Hufhammer	20–21
Berliner Dachkelle	55	Dreikant-Vollschaber	48			Hufschmiedehammer	20
Berliner Schere	51	E		Ganzstahl-Latthammer	12		
Betonschalmeister	10	Eckfalzzange	48	Gärtnerspaten	27	I	
Betonstampfer	26	Eckschaleisen	44	Gärtnerspaten mit T-Griff	27	Idealschere	52–53
Biberschwanzkelle	56	Einbahniger Polierhammer	46	General-Handamboss	72		
Biegeisen	74	Einbahniger Spannhammer	46	Geologenhammer	32	J	
Bit-Check Edelstahl	61	Einfacher Ausbeulhammer	69	Gesipa-Handnietzange	54	Japan-Klappsäge	60
Blechkofer	67	Einmann-Bügelsäge	59	"Flipper"		Japansäge mit langem Griff	60
Bodenamboss	43	Einsteckamboss	42–43	Gesipa-Handnietzange NTX	53	Japansäge mit Pistolengriff	60
Bogenzirkel	57	Erdnagelzieher	27	Gipserbeil / Lattbeil	10		
Bördeleisen	41	Ersatzblatt	60	Gipserbeil / Lattbeil	10	K	
Bördelzange	76	Ersatzkordel	58	"BlackGiant"		Kabelmesser	51
Bordsteinzange	26	Ersatzschlagkopf	35	Glaserhammer	29	Kaltschrotmeißel	21
Bossierhammer	24	Ersatzstiel	67–68	Glasfasermaßband	56	Kanaldeckelhammer	32
Brechstange	22	Ersatzteile	39	Goldschmiedehammer	46	Katzenzungenkelle	55
Brechstange (Kuhfuß)	23						
Bruchsteinhammer	26						

Bezeichnung	Seite	Bezeichnung	Seite	Bezeichnung	Seite	Bezeichnung	Seite
K		M		S		T	
Keilhülse	67	Metallsägebogen	59–60	Salzsäureflasche	63	Treibhammer	45
Keilhülsen-Sortiment	67	Mini-Check	61	Sattlerhammer	30	Treppeneisen	31
Kerbmeißel	47	Mini-Check TX	61	Schaleisen	44	Treppenstufen-Versetzzange	27
Kesselsteinhammer	33	Montage- und Hebeleisen	23	Schieferhammer	37–38	Trichter-Sperrhaken	40
Kirschen-Stechbeitel	62	Montagedorn	33	Schiefer-Reparatur-Set	39	T-Shirt "Picard"	77
Kirschen-Zimmermannsbeitel	62	Montagehammer	11	Schlicht- und Kugelhammer	70		
Klanghammer	33	Multifunktion-Klinge / Schaber	64	Schlichthammer	19, 45, 70	U	
Klauenhammer	17–19			Schlitzmeißel	75	Uhrmacher-Ambösschen	47
Klauenhammer "BlackGiant"	18	N		Schlosserhammer	16–17	Uhrmacherhammer	46
Klauenhammer "Little Giant"	19	Nachfüllkreide	58	Schlosserhammer, DIN 1041	13–14	Umschlageisen	41
Kleinamboss	72	Nagelheber	30	Schlüsselband "Picard"	77	Uni-Messer "Allegro"	50
Klein-Bügelsäge	59	Nagelschürze	66	Schmiedehammer	19	Universal-Abisolierzange	54
Klempner-Flachzange	47	Nageltasche	66	Schmiedehammer, kurze Form	19	Universalbohrer GOLDCRAFT	65
Klempner-Rundzange	47	Nietenköpfer	31	Schneeräumer / Schneeschaufel	28	Universal-Hebeleisen	75
Klingen-Klappmesser	50	Nietenquetscher	21	Schnellwechselhalter mit	61	Universalkoffer "Solar"	54
Klingen-Klappmesser "Picard"	77	Nietenzieher	31	Magnet		Universalmesser	49
Knieheber	75	Nietzange	22	Schnurschlaggerät	57–58	Universalschere	52
Knieschoner "Picard"	67	Nylonhammer	37	Schnurschlaggerät "Cosmos"	58	Untersatz	43
Knipex-Alligator	54			Schnurschlaggerät "Rapido"	58		
Knipex-Cobra	54	P		Schnurwasserwaage	57	V	
Knipex-Kneifzange	54	Pappreißmesser	51	Schon-Aufsatz	14	VDE-Kabelschere	55
Knipex-Kraftmonierzange	54	Pelikanschere	52	Schoßmaul-Schmiedezange	21	Verbundsteinzieher	27
Knipex-Monierzange	54	Pflasterbrechstange	23	Schreibblock "Picard"	77	Versetzzange	27
(Rabitzzange)		Pflasterhammer	25	Schreinerhammer	37	Vorschlaghammer, DIN 1042	14
Knopfamboss	43	Pflasterramme	26	Schreinerhammer, DIN 5109	37		
komb. Nietenzieher u. -köpfer	31	Pflastersteinzange	27	Schreinerwinkel	56	W	
Kombi-Hammer	12	Phillips-Bit	61	Schusterhammer	32	Warmschrotmeißel	21
Koppelschloss	66	Pickhammer	70	Schweifhammer	45	Wasserwaage	57
Körner	31	Pinnhammer	17	Schweifstock	40	Weichmetallfeile	49
Kotflügelbiegezange	76	Plastikhammer	36	Schweißerhammer	33–34	Werkzeugkette	65
Kreuzschlaghammer, DIN 1042	14	Plattenlegerhammer	25	Setzhammer-Oberteil	19	Winkeldoppelfalzer	49
(B)		Plattenlegerramme	26	Setzhammer-Unterteil	19	Winkelfalzschließer	49
Kreuzschweifhammer	46	Polierhammer	45	Sickenhammer	46	Wolfsmaul-Schmiedezange	21
Küfersetzhammer	33	Polsterhammer	30	Sickenstock	40		
Kuhfuß	23	Pozidriv-Bit	61	Silberschmiede-Pinnhammer	46	Z	
Kunststoffkoffer	67	Prelleisen	25	Silberschmiede-Schlichthammer	46	Zahnbeil	11
Kupferhammer	34	Pritschhammer	46	Silberschmiede-Sperrhaken	47	Zahnhammer	11
		Punzensatz	47	Silberschmiede-Tellerhammer	46	Zangenschlaufe	65
L				Spann-, Ausbeul- u.	69, 71	Ziegelkniefzange	39
Lagerschaber	49	Q		Schlichthammer		Zimmererschnurschlag	58
Langlochzange	54	Quetschfalzeisen	40	Spannhammer	45	Zimmermannsaxt	62
Lattbeil	12	Quetschfalzzange	48	Spenglerhammer	35–36	Zimmermannsaxt "Standard"	62
Lattenstichmaß	57			Sperrhaken	39	Zimmermannsbeil	62
Latthammer	9, 37	R		Spezial Ausbeul- u.	71	Zimmermannsbleistift	56
Latthammer "BlackGiant"	10	Randsteinheber	27	Pinnhammer		Zimmermannsklüpfel	36
Latthammer, DIN 7239	9–10	Rapidaptor Universalhalter	62	Spezial Ausbeul- u.	71	Zimmermannswinkel	56
Lederkoppel	66	Reifenheber	75	Schlichthammer		Zugmesser	63
Leichtmetallhammer	34	Reißnadel	57	Spezialgürtel	66		
Lenkdrachen "Picard"	77	Richteisen	27	Spitzhammer	39	Abkürzungen	
Lochschere	51	Ringpinsel	64	Spitzzirkel	57	OS	ohne Stiel
Losschlageisen	30	Rinneisenabbiegezange	49	Stahlbandmaß HiLock	56	ES	mit Eschenstiel
Lötsalmiakstein	63	Rinnenfaust	44	Stahldrahtbürste	64	HS	mit Hickorstiel
Lötwasserflasche	63	Rinnen-Richtheber	49	Steinspalthammer	24	RS	mit Rohrstiel
Lötwasserpinsel	63	Rodespaten mit T-Griff	27	Stichaxt	63	FS	mit Fiberglasstiel
Löwenkopfkette	65	Rohreinziehzange	53	Stichsäge	59	KS	mit Kunststoffstiel
		Rohrsäge	59	Stieldurchschlag	20	ZN	Zolltarifnummer
M		Rohrstange	44	Stiftamboss	40–41		
Magnethammer	29	Rohrstangenhalter	44	Stockhammer	24		
Malerspachtel	64	Rollbrechstange mit Eisenrollen	23	Stockhammer-Einsatz	24		
Maurerhammer	11, 25–26	Rollbrechstange mit	23	Swinger	65		
Maurerhammer "BlackGiant"	11	Gummirollen					
Maurerhammer, DIN 5108	25	Rollkopf-Hebeleisen	75	T			
Maurerkelle, S-Hals	56	Roststecher	33	Tapezierhammer	30		
Maurerschnur	58	Rückschlagfreier Schonhammer	34–35	Tasso	43		
Mechanikerhammer	17	Rundamboss	72	Tellerhammer	45		
Meißelhandschutz	31	Rundgesenk-Oberteil	19	Tischlerschmiege	56		
Meißelmeister DBGM	12	Rundgesenk-Unterteil	19	Töpferhammer	32		
Messer "Delphin" im Köcher	50	Rundlochscherer	51	TORX-Bit	61		
Messerscheide	66	Rundmaul-Schmiedezange	21	Trapezklinge	50		
Messer-Set	50			Traufenkanter	49		
Messingdrahtbürste	64			Taufenschließer	49		

Product Groups	Page	Product Groups	Page
1 Tools with tubular steel shaft	9 - 12	14 Tools for Plumbers, Gold- and Silversmiths and Watchmakers	39 - 49
2 Rivetting and Sledge Hammers, Mining Sledges	13 - 17	15 Knives and Blades	49 - 51
3 Claw Hammers	17 - 19	16 Tongs and Shears	51 - 55
4 Blacksmiths' and Farriers' Tools	19 - 22	17 Trowels	55 - 56
5 Crow Bars	22 - 23	18 Measuring and Scribing Tools	56 - 58
6 Pavers', Bricklayers', Stone Working and Landscape gardener Tools	24 - 28	19 Saws and Saw Blades	59 - 60
7 Upholsterers', Decorators' and Carpet Layers' Tools	29 - 31	20 Bits	60 - 62
8 Rivet Punches, Rivet Sets and Centre Punches	31	21 Hatchets, Axes and Hammertackers	62 - 63
9 Special Tools	32 - 33	22 Brushes, Scrapers, etc.	63 - 65
10 Welders' and Boiler Scaling Hammers	33 - 34	23 Leather Articles, Tool Boxes	65 - 67
11 Soft Face Hammers	34 - 37	24 Handles and Wedges	67 - 69
12 Carpenters' and Joiners' Tools	37	25 Bumping Tools	69 - 77
13 Special Roofmakers' Tools	37 - 39	26 promotional articles	77
		Numerical Overview	8

Description	Page	Description	Page	Description	Page	Description	Page
A		B		C		G	
Adjustable Sliding Bevel	56	Bumping Hammer	70-71	COTTA-Marking device	57	Gesipa Riveting Tong NTX	53
ALPHA-Marking device	57	Bumping Hammer double	69	Crimp System Pliers	55	Glaziers' Hammer	29
Aluminium hammer	34	Bumping Hammer single	69	Cross peen Hammer	17	Goldsmiths' Hammer	46
American spoon scraper	49	Bumping Plier	76	Cross Pein and Finishing Hammer	70-71	Grip Plier	54
Ammonia stone	63	Bumping Tool Set	76-77	Crow Bar	22	Grooving Hammer	45
Angle Flat Scraper	44	Bush Chisel	24-25	Crow Bar for pavers	23	G-SAW ALUMINIST type	60
Anvil beak	20	Bush Chisel with edge	25	cutting chisle	75	Gutter-adjusting plier	49
Anvil Block	73-74	Bush Hammer	24			Gutter-outlet forming plier	49
Anvil for Bearing Irons	42-43			D		H	
Anvil for Silversmiths	47	Cable knife	51	Dolly	72	Hack saw blade for metal	60
Anvil for Slaters	38	Cable Shear	55	Double headed Plumbers' Hammer	45	Hacksaw frame	59-60
Anvil for Tinkers	39-41	Caps of NYLON	14	Double Seamer	49	Hammer for Angle Flat Scraper	44
Aviation Snip	52	Cardboard tracing knife	51	Double Welt Iron	44	Hammer for carpet layers	30
Axe	62	Carpenters chalk line	58	Drawing Knife	63	Hammer for electric welders	33-34
		Carpenters' Chisel	62	Drift Pin	33	Hammer for Flaglayers	29
B		Carpenter's hatchet	62	Drifts or punches, round	20	Hammer for geologists	32
Balanced Ding Hammer	70	Carpenter's Mallet	36	Drifts or punches, square	20	Hammer for Inlaid Woodwork	37
Ball End Hammer	70	Carpenter's pencil	56	Drip edge bender	49	Hammer for orange cases	33
Base Moulding Lifter	23	Carpenters' pincer	54	Drip edge seamer	49	Hammer for pavers	25
Batten Gauge	57	Carpenters' Pinching-bar	22-23	Dutch Shovel	28	Hammer for Potters	32
Beating iron for body repair	74	Carpenters' Roofing Ham	9-10, 12, 37			Hammer for upholsterers	30
Bending iron	74	Carpenters' Roofing Hammer	10	E		Hammer tackler	63
Bending Plier	76	"BlackGiant"		Embossing Hammer	24, 45	Hand and Rivetting Hammer	13-14
Berlin pattern snip	51	Carpenter's square w. holes	56	Engineers Hammer	16-17	Hand Riveting Tong	53
Bit-Check, stainless	61	Caulking gun	64	Engine-Fitters' Hammer	11	Hand saw	59
Bit-Safe	60-61	Centre Punche	31			Hardie	20
Blacksmith' Hammer	19	Chalk line reel	57-58	F		Hatchet	62
Blacksmiths' Tong	21-22	Chalk line reel "Cosmos"	58	Farriers' Hammer	20	Hatchet Stake	41
Blacksmiths' Tong, flat nosed	21	Chalk line reel "Rapido"	58	Ferroplex-Hammer	35	Heel Dolly	72
Blacksmiths' Tong, round nosed	21	Chasing Hammer	45-46	Fibre glass measuring tape	56	high-tech screw releaser / stainless steel protector	62
Blacksmiths' Tong, wolf's jaw	21	Chasing Hammer for Silversmiths	46	File Blade only	76	Holsteiner Shovel	28
Boiler Scaling Hammer	33	Chisel / Mining Sledge	12	Firmer chisel	62	Hooked blade, 0,63 mm	50
Bording Hammer	46	Claw Hammer	17-19	Flaging Plier	76	Hook-Socket	40
Bording socket	41	Claw Hammer "BlackGiant"	18	Flat Plier for Plumbers	47	Hot cutting Chisel	21
Bottom Fuller	20	Claw Hammer "Little Giant"	19	Flat scraper	44, 49	Hydrochloric acid bottle	63
Bottom Hammer	19	Cold cutting Chisel	21	Foamy Plastics Cutter Blade	51		
Bottom socket	43	Combination blade straight and hooks	50	folding blade saw	60		
Bottom Swage	19, 47	Compass	57	Folding locking utility knife	50, 77		
Bow saw	59	Compass-saw	59	Folding Plier for Plumbers	47-48		
Brasiers' Anvil	43	Concrete rammer	26	Frankfurter Shovel	28	I	
Brass wire brush	64	Cooper Hammer	34	Fretting Anvil	40	Industrial and professional shear	53
Break-away blade	51	Coopers' Hammer	33			Inn Pry and Surfacing	75
Breaking-off plier	76	Cord spirit level	57	G		Insulation knife	51
Buckle for belts	66	Corner seaming and clinching plier	48	General Purpose Anvil Block	72		
Bumping and Planishing Hammer	72			Gesipa Hand Riveting Tong	54		
				"Flipper"			

Description	Page	Description	Page	Description	Page	Description	Page
J		P		S		W	
Joiners' Hammer	37	Plumb line	58	Special-bow-saw	59	Working Stand	44
Joiner's Square	56	Plumbers' Hammer	35-36	Spirit level	57		
Junior hack saw	59	Polishing Hammer	45-46	Springs for tin snips	52		
K		precision cross-cut saw	60	Square flat Anvil	40		
Kerbstone tong	26	Pressure roller	65	Square Flatter	19	Abbreviations:	
Knee pads	67	Professional Utility Knife	50	Squeezing Folding Plier	40	OS	without handle
Knife-set	50	Pry and Bumpind Spoon	75	Stair Tool	31	ES	with ash handle
Knife for slaters	51	Pry and Bumping Spoon	75	Stand	43	HS	with hickory handle
L		Pry Bar	75	Staples	63	RS	with tubular steel shaft
Large Face Boiler-Makers' Hammer	46	Punch Snip	51	Steel Square with back	56	FS	with fibreglass-handle
Leather belt	66	Punch Snip with Curved Blades	51	Steel wire brush	64	KS	with plastic handle
Leather tool holder	65-66	R		Stone Breakers' Hammer	26	ZN	customs tariff
Locksmiths' Hammer	17	Radiator brush	64	Stone Sledge	24		
Long Low spot Pick Hammer	70	Rapidaptor Universal Bit Holder, stainless	62	Straight blade, 0,63 mm	50	Additional information:	
Loose Dies for Bush Hammers	24	Refill Line	58	Stretching Hammer	45-46	glatt	plain
Loose faces for Non-rebound Hammers	35	Replacement chalk powder	58	Styrofoam saw	59	geraut	checked
M		Retractable racor blade knife	50	T		verchromt	chromium-plated
Magnetic bit holder	61	Rivet Punche	31	Tile / Brick Drill Bits	65	vergoldet	gold-plated
Magnetic Hammer	29	Rivet Set	31	KERAMIK		Ersatzstiel	spare handle
Masons' Hammer	11, 25-26	Rivet Set and Punch in one piece	31	Tile-Nibbler	39	Ersatzkopf	spare head
Masons' Hammer "BlackGiant"	11	Rivetting Hammer	13	Tilers' Hammer	37-39	matt	dull
Masons' Hammer toothed	11	Rivetting Tong	22	Tilers' Hatchet	10, 12	poliert	polished
Mason's trowel	56	Roof Wedge Anvil Block	73	Tilers' Hatchet "BlackGiant"	10	rechts	right
Mechanicians' Hammer "Combi"	12	Roofer's saw	59	Tilers' Hatchet toothed	11	links	left
Metal Shrinking and Bumping Hammer	69	Rooflayer's trowel	55-56	Tilers' Nail Puller	38	Geschenkkarton	gift wrapping
Metal tool box	67	Round Nose Plier for Plumbers	47	Tilers' Repair Set	39		
Milled curved tooth file	76	Round wedges	67	Tin file	49		
Mining Sledge	12, 15-16	Rubber Mallet	36	Tinmen's / Pelikan Snip	52		
Mortice Axe	63	Rubber Top for Mining Sledge	15	tire leaver	75		
Moulding Anvil for Tinkers	40	Rust Scratcher	33	Tong for paving stones	27		
N		S		Tonge shaped trowel	55		
Nail Apron for Slaters	66	Scaling Hammer	34	Tongue trowel	55		
Nail puller	30	Scriber	57	Tool case for photovoltaics	54		
Nail Purse	66	Scribing iron	57	Tool for removing nails	30		
Necking tool	47	Scythe Anvil	33	Tool holder	65		
Non-rebound Hammer	34-35	Scythe Hammer	32-33	Top Fuller	20		
Notch punching machine	54	Seam opening plier	48	Top Swage	19		
Nylon Hammer	37	Seaming plier for high seams	48	Topping - Mallet	36		
P		Set for chased work	47	TORX-Bit, stainless	61		
Paint brush	64	Set Hammer	19	Tower Pincer	54		
Painters' Scraper	64	Shape and Straight Cutting Snip	52-53	Triangle hollow scraper	48		
Pattern Makers' Hammer	17	Shape Cutting Punch Snip	52	Triangle scraper	48		
Pavers' beetle	26	Shear for Tilers	39	Triangle spoon scraper	49		
Pavers' Hammer	25	Shingle Cutter	39	Trimming Knife "Allegro"	50		
Pick Hammer	70	Shoeing Hammer	20-21	U			
Pinching Bar for construction work	23	Shoemakers' Hammer	32	Universal chisel hand guard	31		
Pinching Bar with iron rollers	23	Shovel	28	Universal Drill Bits	65		
Pinching Bar with rubber rollers	23	Shrinking Hammer	71	GOLDCRAFT			
Pipe Anvil	44	Side chisel	21	Universal Insulation Stripper	54		
Pipe narrowing plier	53	Single lock hand seamer	49	Universal knife	49		
Planishing and Grooving Hammer	46	Sledge Hammer	14	Universal knife with retractable blade	50		
Planishing Hammer	45, 69-71	Snow shovel	28	Universal Snip	52		
Planishing Hammer double	69	Socket	42-44	Universal Snip with Wide Blade	52		
Planishing Hammer for Silversmiths	46	Soldering fluid bottle	63	Utility Dolly	72-74		
Plastic Hammer	36	Soldering fluid brush	63	V			
Plastic tool box	67	Spade	27-28	Varnish brush	64		
		Spading Fork	28	W			
		Spare handles	67-69	Watchmakers' Anvil	47		
		Spare parts	39	Watchmakers' Hammer	46		
		Special Grooving Hammer	46	Water Pump Plier	54		
		Special Hammer	31	Water Pump Plier "Alligator"	54		
		Special Hammer for water-works	32	Wood Splitting-Hammer	32		
				Wooden folding rule	56		
				Wooden Mallet	34		
				Working Block	44		

Groupes des produits	Page	Groupes des produits	Page
1 Outils avec manche tube	9 - 12	16 Tenailles et Cisailles	51 - 55
2 Marteaux d'ajusteurs, Marteaux de devant, Masses	13 - 17	17 Truelles	55 - 56
3 Marteaux fendus	17 - 19	18 Outils à mesurer et à tracer	56 - 58
4 Outils de forge et de maréchal	19 - 22	19 Scies et Lames de scie	59 - 60
5 Pincés en acier	22 - 23	20 Bits	60 - 62
6 Outils de paveur, de maçon	24 - 28	21 Hachettes, Haches, Marteaux à agrafes	62 - 63
7 Outils de décorateur et de tapicier	29 - 31	22 Brosses, Spatules, etc.	63 - 65
8 Bouterolles, Chasses Rivets et Pointeaux	31	23 Articles en Cuir, Caisses d'outils	65 - 67
9 Outils spéciaux	32 - 33	24 Manches et Cales	67 - 69
10 Marteaux de soudeur, Marteaux à piquer les soudures	33 - 34	25 Outils de débosselage	69 - 77
11 Marteaux à tête douce	34 - 37	26 Promotional	77
12 Marteaux de plafonneur et de menuisier	37	Tableau numérique	8
13 Outils spéciaux de couvreur	37 - 39		
14 Outils pour ferblantier, horloger, orfèvre, ciseleur	39 - 49		
15 Couteaux et Lames	49 - 51		

Désignation	Page	Désignation	Page	Désignation	Page	Désignation	Page
A		C		E		L	
Adaptateur universel	62	Cisaille passe tôle type	52	Enclumette	72	Lame à crochets, 0,63 mm	50
Rapidaptor, acier inoxydable		Pélican		Enclumette de couvreurs	38	Lame combinaison droite et	50
Agrafes	63	Cisaille universelle	52	Enclumette pour faux	33	crochet	
Arc de scie à métaux	59-60	Cisaille universelle avec une	52	Enclumette pour orfèvres	47	Lame détachable	51
Arrache-clou de couvreurs	38	lame large		Equerre à butée	56	Lame droite, 0,63 mm	50
Arrache-clou de garnisseurs	30	Ciseau	47	Equerre de charpentiers avec	56	Lame pour métal	60
Arrache-clou, spécial	23	Ciseau à bois	62	trou		Langue de chat	55
B		Ciseau à boucharder	24-25	Equerre de menuisier	56	Lanière	65
Barre à débosser	75	Ciseau de charpentier	63	Etampe	19	Lanière en cuir	65-66
Barre à mine - Arrache clou	22-23	Ciseau de travail	53	Etampe à dégorger	20	Levier avec taillant pour	23
Barre à mine avec 2 roulettes	23	Ciseau pour couvreurs	39			montage	
en caoutchouc		Ciseau de garnisseur	30	F		Levier pour carrossiers	75
Barre à mine avec 2 roulettes	23	Coffret à outils en métal	67	Fer à cingler pour border	40	licencié de pneu	75
en fer		Coffret à outils en plastique	67	Fer à cintrer	74	Lime fraisée seule	76
Barre de Toliens	44	Compas	57	Fer double-pli	44	Lime pour étain	49
Bèche	27-28	Cordeau à tracer	57-58	Flacon pour acide	63		
Bigorne à rainures pour	40	"Cosmos"	58	chlorhydrique		M	
ferblantiers		Cordeau à tracer "Rapido"	58	Flacon pour eau à souder	63	Maillet caoutchouc	36
Bigorne pour ferblantiers	39-40	Cordeau de charpentier	58	Fourche Bèche	28	Maillet de bois	34
Bit-boîte safe	60-61	double		Frappe à boucharder	24	Maillet de charpentiers	36
Bloc de Travail	44	Cordeau de maçon	58	Frappe de débosselage	74	Maillet Ferroplex	35
Boucharde	24	Cordeau de rechange	58			Mallette d'outils pour la	54
Boucle de ceinture	66	Coup de NYLON	14	G		photovoltaïque	
Bouterolle	31	Coupe-bardeau d'asphalte	39	Gesipa pince à main	53-54	Manches individuels	67-69
Bouterolle et Chasse rivet	31	Coupe-câbles cuivre el	55	Grattoir creux tranchant	49	Marteau / Burin	12
combiné en une pièce		aluminium		Grattoir creux triangulaire	49	Marteau à agrafes	63
Brosse à manche en fil	64	Couteau	63	Grattoir droit	33	Marteau à battre les faux	32-33
d'acier		Couteau "Allegro"	50	Grattoir plat	49	Marteau à boucharder	24
Brosse en fil de laiton	64	Couteau à lame rétractable	50	Grattoir triangulaire évidés	48	Marteau à bouge	45
Brosse persienne industrielle	64	Couteau avec lame	50	Grattoir triangulaire massifs	48	Marteau à débosser	69-71
Brosse pour radiateurs	64	rétractable				Marteau à débosser double	69
C		Couteau de peintre	64	H		Marteau à débosser et à	70
Cales cylindriques	67	Couteau pour câble	51	Hache	62	boule combiné	
Capot à tête en caoutchouc	15	Couteau pour couvreurs	51	Hachette	62	Marteau à débosser et à	71-72
pour masses		Couteau pour matériaux	51	Hachette de charpentiers	62	planer	
Ceinture en cuir	66	isolants		Hachette pour couvreurs	10, 12	Marteau à débosser simple	69
Chasse à parer	19	Couteau universel	49	Hachette pour couvreurs	10	Marteau à emboutir	45
Chasse carrée	19	Couteau-traceur à carton	51	"BlackGiant"		Marteau à étirer	45-46
Chasse rivet	31	Couteaux pliants	50, 77	Hachette pour couvreurs	11	Marteau à fendre le bois	32
Cisaille bichantourneuse et à	52-53	Crayon pour charpentier	56	avec denture		Marteau à gorge	45
coupe continue		D		Hasse à brique	25	Marteau à piquer les	34
Cisaille bichantourneuse et	52	dégrippant de boulons /	62			chaudières	
coupe-trou		protecteur pour acier		J		Marteau à piquer pour	33
Cisaille coupe-trous	51	inoxydable		Jeu à ciseler	47	chaudières	
Cisaille coupe-trous ronds	51	Demoiselle d'acier	26	L		Marteau à planer	70
Cisaille façon Berlin	51			Lame à couper plastiques	51	Marteau à planer double	69
				cellulaire		Marteau à planer et à boule	70
						combiné	

Désignation	Page	Désignation	Page	Désignation	Page	Désignation	Page
M		M		R		T	
Marteau à planer et à débosser	69–71	Mesure d'écartement pour lattes	57	Rebatoir	43	Truelle de maçon	56
Marteau à planer et suager	46	Mètre pliant en bois	56	ressort	52		
Marteau à planer pour forgerons	20	N		Rouleau de pression	65		
Marteau à planer pour orfèvres	46	Niveau à eau	57	Ruban de mesure	56		
Marteau à plaqueur	70–71	O		S		Abréviations:	
Marteau à polir	45–46	Outil spéciau	31	Sauterelle de menuisier-ébéniste	56	OS sans manche
Marteau à suage	46	Outils pour chevaltes	44	Scie à bûches	59	ES avec manche frêne
Marteau avec pêne	17	Outils de débosselage	76–77	Scie à bûches idéale	59	HS avec manche en hickory
Marteau d'ajusteurs	13–14, 16–17	P		Scie à guichet	59	RS avec manche en tube d'acier
Marteau d'aluminium	34	Pare-main universel	31	Scie à métaux	59	FS avec manche en fibre de verre
Marteau de carreleurs	29	Pelle	28	Scie de couvreurs	59	KS avec manche en matière plastique
Marteau de carriers	26	Pelle Alsace	28	Scie égoïne	59	ZN tarif douanier
Marteau de ciseleurs	46	Petit marteau de mécaniciens	17	Scie japonaise	60	Notes additionnelles:	
Marteau de cordonniers	32	Pied de Biches pour ferblantiers	40	Scie pliable	60	glatt plaine
Marteau de couvreurs	37–39	Pierre à souder	63	Scie pour plaque isolante	59	geraut gaufré
Marteau de devant	14	Pilon à béton	26	Socle s'employer	43	verchromt chromé
Marteau de ferblantiers	36	Pince à border pour coins	48	Sous Etampe	19	vergoldet doré
Marteau de forgerons	19	Pince à débosser	76	Sous Etampe à dégorger	20	Ersatzstiel manche individuel
Marteau de garnisseurs	30	Pince à dénuder universelle	54	Sous Etampe à trancher	20	Ersatzkopf tête seule
Marteau de maçon	11, 25–26	Pince à dresser	48	Sous Etampe conique à élargir	20	matt mat
Marteau de maçon "BlackGiant"	11	Pince à joints debout simple	49	Sous-étampe	47	poliert poli
Marteau de maçon avec denture	11	Pince à main	53	T		rechts droite
Marteau de maréchaux	20–21	Pince à ouvrir les plis, PVC, encastrée	48	Tablier pour couvreurs	66	links gauche
Marteau de menuisiers	37	Pince à poinçonner en obang	54	Tas à main	74	Geschenkkarton paquet-cadeau
Marteau de montage	11	Pince à réduction de tuyaux	53	Tas à main façon talon	72		
Marteau de montage "Combi"	12	Pince à sertir universelle	55	Tas à planer	19		
Marteau de paveur	24–25	Pince à tirer	47–48	Tas à carré	40		
Marteau de plaçage	37	Pince en acier	22–23	Tas de forme "Diabolo"	73		
Marteau de plafonneurs	9–10, 12, 37	Pince pour paveur	23	Tas de forme "Mercedes"	73		
Marteau de plafonneurs "BlackGiant"	10	Pince multiprises	54	Tas de forme semelle	73		
Marteau de potiers	32	Pince multiprises "Alligator"	54	Tas d'horloger	47		
Marteau de sellier	30	Pince plate pour ferblantiers	47	Tas d'utilité générale	72		
Marteau de soudeurs	33–34	Pince plieuse	76	Tas forme de doigt du pied	73		
Marteau de tapiciers	30	Pince pour ajuster les gouttières	49	Tas pour carnes	73		
Marteau de vitriers	29	Pince pour crochets de gouttière	49	Tas pour carrossiers	73		
Marteau d'horlogers	46	Pince pour détacher	76	Tas pour carrossiers	72–74		
Marteau en cuivre	34	Pince pour paveurs	27	Tas pour chaudronniers	43		
Marteau en matière Nylon	37	Pince ronde pour ferblantiers	47	Tas pour chevalets	42–43		
Marteau en matière plastique	36	Pinceau de décapage	63	Tas pour ferblantiers	40–41		
Marteau fendu	18–19	Pincés-étai	54	Tasseau	42–44		
Marteau fendu "BlackGiant"	18	Pistolet au cartouche	64	Tasseau à border	41		
Marteau fendu "Little Giant"	19	Plieuse à larmiers coudée	49	Tasseau à crochet	40		
Marteau fendus	17	Plieuse à larmiers droits	49	Tenaille	54		
Marteau magnétiques	29	Poche	66	Tenaille de forge	22		
Marteau Postillon	45	Pochette composition	50	Tenaille de forge pour	22		
Marteau pour caisses à oranges	33	Poinçon	33	bouterolles			
Marteau pour chaudronniers	46	Poinçon carrée pour forgerons	20	Tenaille de forge pour rivets	22		
Marteau pour couvercle de canal	32	Poinçon rond pour forgerons	20	Tenaille de forge, à bec plat, coquille carrée	21		
Marteau pour ferblantiers	35–36	Pointe à tracer	57	Tenaille de forge, becs	21		
Marteau pour géologues	32	Pointeau	31	gueule de loup			
Marteau pour orfèvres	46	Porte magnétique bit	61	Tenaille de forge, becs plats	21		
Marteau pour paveur	25	Porte-limes	76	Tenaille de forge, becs ronds	21		
Marteau pour racloir d'angle	44	Porte-tenaille	26	Tenaille pour tuiles	39		
Marteau pour tonneliers	33	Poudre de tracage	58	Tenaille russe	54		
Marteau rivoirs	13	Protecteur de genoux	67	Têtes pour Massettes sans rebond	35		
Marteau spécial	31	Q		Tracette à zinc	57		
Marteau spécial à gorge	46	Queue de morue	64	Tracoir ALPHA	57		
Masse à rompre	24	R		Tracoir COTTA	57		
Masse de carriers	12, 15–16	Racloir	44	Tranche	41		
Masse de mineur	15	Racloir d'angle	44	Tranche à chaud	21		
Massette sans rebond	34–35			Tranche à deriver	21		
				Tranche à froid	21		
				Truelle de couvreur	55–56		
				Truelle de langue	55		

1 Stahlrohrwerkzeuge und Ganzstahlhämmer

Tools with tubular steel shaft

Outils avec manche tube

Art. EAN 4016671 EURO

698



Latthammer Carpenters' Roofing Hammer Marteau de plafonneurs

ZN 82052000 PG 2

TÜV, mit magnetischem Nagelhalter, für höchste Ansprüche, Hammerkopf fein blank, Chrom-Molybdän-Stahlrohrstiel, Klaue und Spitze besonders gehärtet, mit hohem Auge, 2-Komponenten-Griff braun/schwarz

with magnetic nailholder, bright polished with tubular steel shaft and 2-components grip brown/black

poli, avec porte-clou magnétique, avec manche en tube d'acier et 2-composants poignée brun/noir



0069800	12	600 g, glatt	009392	38,50
0069810	12	600 g, geraut	000078	38,50

298

Latthammer Carpenters' Roofing Hammer Marteau de plafonneurs

ZN 82052000 PG 2

mit magnetischem Nagelhalter, für höchste Ansprüche, Hammerkopf schwarz lackiert, Chrom-Molybdän-Stahlrohrstiel, Klaue und Spitze besonders gehärtet, mit hohem Auge, brauner Spezialgriff

with magnetic nailholder, bright polished with tubular steel shaft and brown special grip

poli, avec porte-clou magnétique, avec manche en tube d'acier et poignée en plastique



0029800	12	600 g, glatt	009248	36,25
0029810	12	600 g, geraut	009255	36,25
0029850	1	verchromt, geraut	015010	51,45
0029860	1	vergoldet, geraut	020380	104,70
S0029850	1	Geschenkkarton	023367	60,60
S0029860	1	Geschenkkarton	023374	113,85

695



Latthammer Carpenters' Roofing Hammer Marteau de plafonneurs

ZN 82052000 PG 2

TÜV, für höchste Ansprüche, Hammerkopf fein blank, Chrom-Molybdän-Stahlrohrstiel, Klaue und Spitze besonders gehärtet, mit hohem Auge, 2-Komponenten-Griff braun/schwarz

bright polished with tubular steel shaft and 2-components grip brown/black

poli, avec manche en tube d'acier et 2-composants poignée brun/noir



0069500	12	600 g, glatt	009378	34,60
0069510	12	600 g, geraut	009385	34,60

Art. EAN 4016671 EURO

295

Latthammer Carpenters' Roofing Hammer Marteau de plafonneurs

ZN 82052000 PG 2

für höchste Ansprüche, Hammerkopf fein blank, Chrom-Molybdän-Stahlrohrstiel, Klaue und Spitze besonders gehärtet, mit hohem Auge, brauner Spezialgriff

bright polished with tubular steel shaft and brown special grip

poli, avec manche en tube d'acier et poignée en plastique



0029500	12	600 g, glatt	009224	32,20
0029510	12	600 g, geraut	009231	32,20

620M



Latthammer Carpenters' Roofing Hammer Marteau de plafonneurs

ZN 82052000 PG 2

TÜV, mit magnetischem Nagelhalter, Hammerkopf schwarz lackiert, schwarzer Spezialgriff

with magnetic nailholder, black, with tubular steel shaft and black special grip

avec porte-clou magnétique, noir, avec manche en tube d'acier et poignée en plastique



0062000	12	600 g, glatt	009354	21,90
0062010	12	600 g, geraut	009361	21,90

420M

Latthammer Carpenters' Roofing Hammer Marteau de plafonneurs

ZN 82052000 PG 2

mit magnetischem Nagelhalter, Hammerkopf schwarz lackiert, schwarzer Spezialgriff

with magnetic nailholder, black, with tubular steel shaft and black special grip

avec porte-clou magnétique, noir, avec manche en tube d'acier et poignée en plastique



0042000	12	600 g, glatt	009279	20,15
0042010	12	600 g, geraut	000061	20,15

600S



Latthammer, DIN 7239 Carpenters' Roofing Hammer Marteau de plafonneurs

ZN 82052000 PG 2

TÜV, der "Meistgekaufte", Hammerkopf schwarz lackiert, mit Nagelrille, schwarzer Spezialgriff

black, with tubular steel shaft and black special grip

noir, avec manche en tube d'acier et poignée en plastique



0060000	12	600 g, glatt	009330	17,45
0060010	12	600 g, geraut	009347	17,45

Art.			EAN 4016671	EURO
400S				
Latthammer, DIN 7239 Carpenters' Roofing Hammer Marteau de plafonneurs				
ZN 82052000 PG 2 der "Meistgekaufte", Hammerkopf schwarz lackiert, mit Nagelrille, schwarzer Spezialgriff black, with tubular steel shaft and black special grip noir, avec manche en tube d'acier et poignée en plastique				
0040000	12	600 g, glatt	009262	15,70
0040010	12	600 g, geraut	000054	15,70

Art.			EAN	EURO
650				
Betonschalmeister Carpenters' Roofing Hammer Marteau de plafonneurs				
ZN 82052000 PG 2 mit zwei scharfen, gehärteten Kanten "DBGM", speziell ausgebildet zum Abschaben von Betonresten, mit magnetischem Nagelhalter, 2-Komponenten-Griff blau/schwarz with 2 sharp, hardened edges "DBGM", for cleaning remainders of concrete - with magnetic nailholder, 2-components grip blue/black avec 2 arêtes en acier trempé "DBGM", pour gratter les résidus en béton - avec porte-clou magnétique				
0065010	12	600 g, geraut	009484	30,40

Art.			EAN	EURO
820M				
Latthammer "BlackGiant" Carpenters' Roofing Hammer "BlackGiant" Marteau de plafonneurs "BlackGiant"				
ZN 82052000 PG 2 mit magnetischem Nagelhalter, Hammerkopf schwarz lackiert, 2-Komponenten-Griff orange/schwarz, zusätzliches Innenrohr with magnetic nailholder, black, with tubular steel shaft and 2-components grip orange/black, additional pipe inside avec porte-clou magnétique, noirs, avec manche en tube d'acier et 2-composants poignée orange/noir, avec tube additionnel à l'intérieur				
0082000	12	600 g, glatt	020731	26,60
0082010	12	600 g, geraut	020748	26,60

Art.			EAN 4016671	EURO
800S				
Latthammer "BlackGiant" Carpenters' Roofing Hammer "BlackGiant" Marteau de plafonneurs "BlackGiant"				
ZN 82052000 PG 2 Hammerkopf schwarz lackiert, mit Nagelrille, 2-Komponenten-Griff orange/schwarz, zusätzliches Innenrohr black, with tubular steel shaft and 2-components grip orange/black, additional pipe inside noir, avec manche en tube d'acier et 2-composants poignée orange/noir, avec tube additionnel à l'intérieur				
0080000	12	600 g, glatt	020717	22,35
0080010	12	600 g, geraut	020724	22,35

Art.			EAN	EURO
297				
Gipserbeil / Lattbeil Tilers' Hatchet Hachette pour couvreurs				
ZN 82014000 PG 2 schwarzer Spezialgriff with tubular steel shaft and black special grip avec manche en tube d'acier et poignée en plastique				
0029700	12	600 g, geraut	009286	20,40
0029750	1	verchromt	021967	69,35

Art.			EAN	EURO
297 1/2				
Gipserbeil / Lattbeil Tilers' Hatchet Hachette pour couvreurs				
ZN 82014000 PG 2 schwarzer Spezialgriff with tubular steel shaft and black special grip avec manche en tube d'acier et poignée en plastique				
0029790	12	500 g, geraut	000023	20,40

Art.			EAN	EURO
897				
Gipserbeil / Lattbeil "BlackGiant" Tilers' Hatchet "BlackGiant" Hachette pour couvreurs "BlackGiant"				
ZN 82014000 PG 2 2-Komponenten-Griff orange/schwarz, zusätzliches Innenrohr with tubular steel shaft and 2-components grip orange/black, additional pipe inside avec manche en tube d'acier et 2-composants poignée orange/noir, avec tube additionnel à l'intérieur				
0089700	12	600 g, geraut	020786	25,10

Art.			EAN 4016671	EURO
296				
			Zahnbeil Tilers' Hatchet toothed Hachette pour couvreurs avec denture	
			ZN 82014000 PG 2	
			2-Komponenten-Griff blau/schwarz, mit Zahnschneide	
			with tubular steel shaft and 2-components grip blue/black	
			avec manche en tube d'acier et 2-composants poignée bleu/noir	
0029600	12	600 g, geraut	022209	24,45

Art.			EAN 4016671	EURO
275				
			Maurerhammer Masons' Hammer Marteau de maçon	
			ZN 82052000 PG 2	
			rheinische Form, schwarzer Spezialgriff	
			new pattern, with tubular steel shaft and black special grip	
			nouveau modèle, avec manche tube d'acier et poignée en plastique	
0027500	12	600 g, geraut	009194	20,40

Art.			EAN 4016671	EURO
875				
			Maurerhammer "BlackGiant" Masons' Hammer "BlackGiant" Marteau de maçon "BlackGiant"	
			ZN 82052000 PG 2	
			rheinische Form, 2-Komponenten-Griff orange/schwarz, zusätzliches Innenrohr	
			new pattern, with tubular steel shaft and 2-components grip orange/black, additional pipe inside	
			nouveau modèle, avec manche tube d'acier et 2-composants poignée orange/noir, avec tube additionnel à l'intérieur	
0087500	12	600 g, geraut	020755	25,10

Art.			EAN 4016671	EURO
277				
			Maurerhammer Masons' Hammer Marteau de maçon	
			ZN 82052000 PG 2	
			Berliner Form, schwarzer Spezialgriff	
			Berlin pattern, with tubular steel shaft and black special grip	
			modèle Berlin, avec manche tube d'acier et poignée en plastique	
0027700	12	600 g, geraut	000016	20,40
0027750	1	verchromt	021806	69,35
0027760	1	vergoldet	022599	125,45
G0027750	1	Geschenkkarton	022650	78,50
G0027760	1	Geschenkkarton	022667	134,60

Art.			EAN 4016671	EURO
277 1/2				
			Maurerhammer Masons' Hammer Marteau de maçon	
			ZN 82052000 PG 2	
			Berliner Form, schwarzer Spezialgriff	
			Berlin pattern, with tubular steel shaft and black special grip	
			modèle Berlin, avec manche tube d'acier et poignée en plastique	
0027790	12	500 g, geraut	009200	20,40

Art.			EAN 4016671	EURO
877				
			Maurerhammer "BlackGiant" Masons' Hammer "BlackGiant" Marteau de maçon "BlackGiant"	
			ZN 82052000 PG 2	
			Berliner Form, 2-Komponenten-Griff orange/schwarz, zusätzliches Innenrohr	
			Berlin pattern, with tubular steel shaft and 2-components grip orange/black, additional pipe inside	
			modèle Berlin, avec manche tube d'acier et 2-composants poignée orange/noir, avec tube additionnel à l'intérieur	
0087700	12	600 g, geraut	020762	25,10

Art.			EAN 4016671	EURO
276				
			Zahnhammer Masons' Hammer toothed Marteau de maçon avec denture	
			ZN 82052000 PG 2	
			Berliner Form, 2-Komponenten-Griff blau/schwarz, mit Zahnschneide	
			Berlin pattern, with tubular steel shaft and 2-components grip blue/black	
			modèle Berlin, avec manche tube d'acier et 2-composants poignée bleu/noir	
0027600	12	600 g, geraut	022216	24,45

Art.			EAN 4016671	EURO
301				
			Montagehammer Engine-Fitters' Hammer Marteau de montage	
			ZN 82052000 PG 2	
			Schlosserhammer mit Stahlrohrstiel, schwarzer Spezialgriff	
			(Mechanicians' Hammers) with tubular steel shaft and black special grip	
			avec manche en tube d'acier et poignée en plastique	
0030100-300	6	RS	009309	17,85
0030100-500	6	RS	009316	17,85

Art.			EAN 4016671	EURO
------	--	--	----------------	------

302



Kombi-Hammer
Mechanicians' Hammer "Combi"
Marteau de montage "Combi"

ZN 82052000 PG 2

Schlosserhammer mit Nagelzieher und Stahlrohrstiel, schwarzer Spezialgriff
 with nail puller, tubular steel shaft and black special grip
 avec arrache-clous, manche tube d'acier, poignée en plastique

0030200	6	RS 300 g	009323	20,40
---------	---	----------	--------	-------

Art.			EAN 4016671	EURO
------	--	--	----------------	------

304



Fäustel, DIN 6475
Mining Sledge
Masse de carriers

ZN 82052000 PG 2

mit Stahlrohrstiel, schwarzer Spezialgriff
 with tubular steel shaft and black special grip
 avec manche tube d'acier, poignée en plastique

0030400-1000	6	RS	000030	17,50
0030400-1250	6	RS	000047	17,50

Art.			EAN 4016671	EURO
------	--	--	----------------	------

304 1/2



Meißelmeister DBGM
Chisel / Mining Sledge
Marteau / Burin

ZN 82052000 PG 2

zwei Funktionen in einem Werkzeug; zum einhändigen Stemmen von Schlitzern usw., 2-Komponenten-Griff blau/schwarz
 two functions in one tool, for one-hand press of slots etc., with tubular steel shaft and 2-components grip blue/black
 avec manche en tube d'acier et 2-composants poignée bleu/noir, deux fonctions dans un outil

0030490-600	6	RS, 600 g	021813	19,20
0030490-800	6	RS, 800 g	021820	19,20

Art.			EAN 4016671	EURO
------	--	--	----------------	------

790



Ganzstahl-Latthammer
Carpenters' Roofing Hammer
Marteau de plafonneurs

ZN 82052000 PG 2

mit Ledergriff aus echtem Kernleder, magnetischer Nagelhalter, aus hochwertigem Vergütungsstahl gefertigt
 with magnetic nailholder and leather grip, plain or checked face
 avec porte-clou magnétique, avec manche en cuir

0079000	12	glatt	023084	67,20
0079010	12	geraut	023091	67,20
S0079010	1	Geschenkkarton	023381	76,35

Art.			EAN 4016671	EURO
------	--	--	----------------	------

797



Lattbeil
Tilers' Hatchet
Hachette pour couvreurs

ZN 82014000 PG 2

mit Ledergriff
 with leather handle
 avec manche en cuir

0079700	12		023114	77,65
---------	----	--	--------	-------

Art.			EAN 4016671	EURO
------	--	--	----------------	------

590



Ganzstahl-Latthammer
Carpenters' Roofing Hammer
Marteau de plafonneurs

ZN 82052000 PG 2

mit 2-Komponenten-Griff rot/schwarz, magnetischer Nagelhalter, aus hochwertigem Vergütungsstahl gefertigt
 with magnetic nailholder and 2-components grip red/black, plain or checked face
 avec porte-clou magnétique, avec 2-composants poignée rouge/noir

0059000	12	glatt	024579	50,60
0059010	12	geraut	024562	50,60

2 Schlosser-, Vorschlaghämmer und Fäustel Rivetting and Sledge Hammers, Mining Sledges Marteaux d'ajusteurs, Marteaux de devant, Masses

Art. EAN 4016671 EURO

1 Schlosserhammer, DIN 1041
Hand and Rivetting Hammer
Marteau d'ajusteurs



ZN 82052000 PG 1
deutsche Form
German pattern
forme Europe Centrale

0000100-0050	1	OS	011562	8,35
0000100-0100	1	OS	011579	8,35
0000100-0150	1	OS	011586	8,35
0000100-0200	1	OS	011593	8,35
0000100-0250	1	OS	011609	8,75
0000100-0300	1	OS	011616	8,85
0000100-0400	1	OS	011623	9,70
0000100-0500	1	OS	011630	9,95
0000100-0600	1	OS	011647	11,95
0000100-0800	1	OS	011654	14,30
0000100-1000	1	OS	011661	16,75
0000100-1250	1	OS	011678	23,50
0000100-1500	1	OS	011685	23,70
0000100-2000	1	OS	011692	32,30
0000101-0050	12	ES	000085	9,75
0000101-0100	12	ES	000092	9,75
0000101-0150	12	ES	000108	9,75
0000101-0200	12	ES	000115	9,75
0000101-0250	12	ES	000122	10,65
0000101-0300	12	ES	000139	10,65
0000101-0400	12	ES	000146	11,75
0000101-0500	12	ES	000153	12,35
0000101-0600	12	ES	000160	14,95
0000101-0800	6	ES	000177	17,00
0000101-1000	6	ES	000184	20,05
0000101-1250	6	ES	000191	26,80
0000101-1500	6	ES	000207	26,80
0000101-2000	6	ES	000214	34,45
0000102-0100	12	HS	000238	10,40
0000102-0150	12	HS	000245	10,40
0000102-0200	12	HS	000252	10,40
0000102-0250	12	HS	000269	11,70
0000102-0300	12	HS	000276	11,70
0000102-0400	12	HS	000283	12,60
0000102-0500	12	HS	000290	13,80
0000102-0600	12	HS	000306	16,45
0000102-0800	6	HS	000313	18,30
0000102-1000	6	HS	000320	21,65
0000102-1250	6	HS	000337	27,80
0000102-1500	6	HS	000344	27,80
0000102-2000	6	HS	000351	36,05

Art. EAN 4016671 EURO

11 Schlosserhammer, DIN 1041
Hand and Rivetting Hammer
Marteau rivoirs



ZN 82052000 PG 1

Ausführung INDUKTIV, Randzone der Hammerbahn elektro-induktiv angelassen, mit Hickorstiel

INDU, with electro-inductive tempered face
modèle INDU, face revenue par electro-induction

0001102-0200	12	HS	000368	12,20
0001102-0300	12	HS	000375	14,65
0001102-0500	12	HS	000382	16,75
0001102-0800	6	HS	000399	21,90
0001102-1000	6	HS	000405	26,00
0001102-1500	6	HS	000412	33,30
0001102-2000	6	HS	000429	43,95

303a Schlosserhammer, DIN 1041
Rivetting Hammer
Marteau d'ajusteurs



ZN 82052000 PG 1

mit Stielschutzhülse, mit Hickorstiel

German pattern with safety-hull, with hickory handle

forme Europe Centrale avec douille de protection, avec manche en hickory

0030312-0200	12	HS	000504	11,40
0030312-0300	12	HS	000511	12,80
0030312-0400	12	HS	000528	13,85
0030312-0500	12	HS	000535	15,20
0030312-0600	12	HS	000542	18,20
0030312-0800	6	HS	000559	20,30
0030312-1000	6	HS	000566	23,85
0030312-1500	6	HS	022971	30,95
0030312-2000	6	HS	022988	39,55

305 Schlosserhammer, DIN 1041
Rivetting Hammer
Marteau d'ajusteurs



ZN 82052000 PG 1

deutsche Form, mit Kunststoffstiel aus Ultramid

German pattern, with Ultramid handle

forme Europe Centrale avec manche en Ultramid

0030500-0200	12	KS	000573	12,60
0030500-0300	12	KS	000580	13,55
0030500-0500	12	KS	000597	16,25
0030500-0800	6	KS	000603	23,05
0030500-1000	6	KS	000610	26,25
0099305-0200	1	Ersatzstiel	019308	6,25
0099305-0300	1	Ersatzstiel	019315	7,15
0099305-0500	1	Ersatzstiel	019322	8,60
0099305-0800	1	Ersatzstiel	019339	10,60
0099305-1000	1	Ersatzstiel	019346	13,05

Art.			EAN 4016671	EURO
321				
Schlosserhammer, DIN 1041 Hand and Rivetting Hammer Marteau d'ajusteurs				
ZN 82052000 PG 1 deutsche Form, mit Fiberglasstiel German pattern, with fibreglas-handle and rubber grip forme Europe Centrale, avec manche en fibre de verre poignée de caoutchouc				
0032100-0200	12	FS	000627	24,10
0032100-0300	12	FS	000634	25,10
0032100-0400	12	FS	000641	27,60
0032100-0500	12	FS	000658	29,40
0032100-0600	12	FS	000665	31,55
0032100-0800	6	FS	000672	36,45
0032100-1000	6	FS	000689	40,80
0032100-1500	6	FS	000696	47,85
0032100-2000	6	FS	000702	61,75

Art.			EAN 4016671	EURO
327				
Schlosserhammer, DIN 1041 Hand and Rivetting Hammer Marteau d'ajusteurs				
ZN 82052000 PG 1 deutsche Form, Voll-Kunststoff-Stiel mit innenliegendem Fiberglaskern German pattern, with fibreglas-handle (fully covered) forme Europe Centrale, avec manche en fibre de verre				
0032700-0300	6	FS	026290	13,00
0032700-0500	6	FS	026306	15,40
0032700-0800	6	FS	026313	19,75

Art.			EAN 4016671	EURO
1b				
Schon-Aufsatz Caps of NYLON Coup de NYLON				
ZN 39269097 PG 1 für Schlosserhämmer suitable for hand and rivetting hammers s'employer pour marteaux d'ajusteurs				
0000120-0300	1		000719	4,70
0000120-0500	1		000726	7,55
0000120-0800	1		000733	8,85
0000120-1000	1		000740	11,55

Art.			EAN 4016671	EURO
2				
Vorschlaghammer, DIN 1042 Sledge Hammer Marteau de devant				
ZN 82052000 PG 1 mit geradem Stiel cross peen pène en travers				
0000201-03	1	ES 3 kg	000818	35,45
0000201-04	1	ES 4 kg	000825	42,20
0000201-05	1	ES 5 kg	000832	50,35
0000201-06	1	ES 6 kg	000849	62,80
0000201-08	1	ES 8 kg	000856	87,90
0000201-10	1	ES 10 kg	000863	107,75
0000202-03	1	HS 3 kg	000870	40,40
0000202-04	1	HS 4 kg	000887	46,50
0000202-05	1	HS 5 kg	000894	57,10
0000202-06	1	HS 6 kg	000900	68,25
0000202-08	1	HS 8 kg	000917	94,90
0000202-10	1	HS 10 kg	000924	114,20

Art.			EAN 4016671	EURO
322				
Vorschlaghammer, DIN 1042 Sledge Hammer Marteau de devant				
ZN 82052000 PG 1 mit Fiberglasstiel cross peen with fibreglas-handle pène en travers, avec manche en fibre de verre				
0032200-03	1	FS 3 kg	000931	96,05
0032200-04	1	FS 4 kg	000948	102,80
0032200-05	1	FS 5 kg	000955	110,00
0032200-06	1	FS 6 kg	000962	122,30
0032200-08	1	FS 8 kg	000979	139,75

Art.			EAN 4016671	EURO
3				
Kreuzschlaghammer, DIN 1042 (B) Sledge Hammer Marteau de devant				
ZN 82052000 PG 1 mit geradem Stiel straight peen pène en long				
0000301-03	1	ES 3 kg	000986	35,45
0000301-04	1	ES 4 kg	000993	42,20
0000301-05	1	ES 5 kg	001006	50,35
0000301-06	1	ES 6 kg	001013	62,80

Art. EAN 4016671 EURO

4



Fäustel, DIN 6475
Mining Sledge
Masse de carriers

ZN 82052000 PG 1
double faced
carrée

0000401-03	1	ES	3 kg	001129	35,45
0000401-04	1	ES	4 kg	001136	42,20
0000401-05	1	ES	5 kg	001143	50,35
0000401-06	1	ES	6 kg	001150	62,80
0000401-08	1	ES	8 kg	001167	87,90
0000401-10	1	ES	10 kg	001174	107,75
0000401-1000	6	ES	1 kg	001082	15,25
0000401-1250	6	ES	1,25 kg	001099	15,70
0000401-1500	6	ES	1,5 kg	001105	16,95
0000401-2000	6	ES	2 kg	001112	22,30
0000402-03	1	HS	3 kg	001228	40,40
0000402-04	1	HS	4 kg	001235	46,50
0000402-05	1	HS	5 kg	001242	57,10
0000402-06	1	HS	6 kg	001259	68,25
0000402-08	1	HS	8 kg	001266	94,90
0000402-10	1	HS	10 kg	001273	114,20
0000402-1000	6	HS	1 kg	001181	17,15
0000402-1250	6	HS	1,25 kg	001198	17,80
0000402-1500	6	HS	1,5 kg	001204	19,40
0000402-2000	6	HS	2 kg	001211	24,70

324



Fäustel, DIN 6475
Mining Sledge
Masse de carriers

ZN 82052000 PG 1
mit Fiberglasstiel
double faced, with fibreglas-handle and rubber grip
carrée, avec manche en fibre de verre poignée de caoutchouc

0032400-03	1	FS	3 kg	001327	96,05
0032400-04	1	FS	4 kg	001334	102,80
0032400-05	1	FS	5 kg	001341	110,00
0032400-06	1	FS	6 kg	001358	122,30
0032400-08	1	FS	8 kg	001365	139,75
0032400-1000	6	FS	1 kg	001280	35,75
0032400-1250	6	FS	1,25 kg	001297	36,20
0032400-1500	6	FS	1,5 kg	001303	38,10
0032400-2000	6	FS	2 kg	001310	43,75

403a



Fäustel, DIN 6475
Mining Sledge
Masse de carriers

ZN 82052000 PG 1
mit Stielschutzhülse, mit Hickorystiel
with safety-hull, with hickory handle
avec douille de protection, avec manche en hickory

0040312-1000	6	HS		022902	19,20
0040312-1250	6	HS		022919	20,10
0040312-1500	6	HS		022926	21,55
0040312-2000	6	HS		022933	27,75

Art. EAN 4016671 EURO

4b



Gummiaufsatz für Fäustel
Rubber Top for Mining Sledge
Capot à tête en caoutchouc pour masses

ZN 39269097 PG 1
für die Größen von 1000 bis 2000 g
for all sizes from 1000 to 2000 gr

0000420-1000	1			001372	5,30
0000420-1250	1			001389	5,30
0000420-1500	1			001396	5,30
0000420-2000	1			001402	5,30

41



Fäustel
Mining Sledge
Masse de mineur

ZN 82052000 PG 1
holländische Form (Moker)
Dutch pattern
modèle hollandais

0004101-1000	6	ES		002928	15,80
0004101-1250	6	ES		002935	16,60
0004101-1500	6	ES		002942	17,85
0004101-2000	6	ES		002959	23,20
0004102-1000	6	HS		002966	18,20
0004102-1250	6	HS		002973	18,80
0004102-1500	6	HS		002980	20,30
0004102-2000	6	HS		002997	25,90

42



Fäustel
Mining Sledge
Masse de mineur

ZN 82052000 PG 1
spanische Form
Spanish pattern
forme espanol

0004201-1000	6	ES		024272	14,80
0004201-1500	6	ES		024289	16,40

342



Fäustel
Mining Sledge
Masse de mineur

ZN 82052000 PG 1
spanische Form, mit Fiberglasstiel
Spanish pattern, with fibreglas-handle
forme espanol, avec manche en fibre de verre

0034250-1000	6	FS		024296	24,90
0034250-1500	6	FS		024302	27,95

Art.			EAN 4016671	EURO
5				
				
Fäustel-Minenhammer Mining Sledge Masse de carriers				
			ZN 82052000	PG 1
engl. Form				
0000501-1000	1	ES	019926	18,20
0000501-1250	1	ES	021431	18,85

Art.			EAN 4016671	EURO
6				
				
Fäustel-Minenhammer Mining Sledge Masse de carriers				
			ZN 82052000	PG 1
(Club-Hammer) Preise auf Anfrage				
0000601-1000	6	ES	020106	0,00
0000601-1250	6	ES	020113	0,00
0000601-1500	6	ES	020120	0,00

Art.			EAN 4016671	EURO
9				
				
Schlosserhammer Engineers Hammer Marteau d'ajusteurs				
			ZN 82052000	PG 1
engl. Form, mit Kugel (Ingenieurhammer)				
with cross peen, English pattern				
à boule, modèle anglais				
0000901-0100	6	ES 1/4 lbs	001457	11,45
0000901-0225	6	ES 1/2 lbs	001464	12,70
0000901-0340	6	ES 3/4 lbs	001471	13,15
0000901-0450	6	ES 1 lbs	001488	14,75
0000901-0500	6	ES 1 1/8 lbs	001495	15,50
0000901-0600	6	ES 1 1/4 lbs	001501	16,75
0000901-0700	6	ES 1 1/2 lbs	001518	18,35
0000901-0800	6	ES 1 3/4 lbs	001525	19,80
0000901-0900	6	ES 2 lbs	001532	21,70
0000902-0100	6	HS 1/4 lbs	001549	13,60
0000902-0225	6	HS 1/2 lbs	001556	14,75
0000902-0340	6	HS 3/4 lbs	001563	15,40
0000902-0450	6	HS 1 lbs	001570	16,90
0000902-0500	6	HS 1 1/8 lbs	001587	18,20
0000902-0600	6	HS 1 1/4 lbs	001594	19,85
0000902-0700	6	HS 1 1/2 lbs	001600	21,35
0000902-0800	6	HS 1 3/4 lbs	001617	22,90
0000902-0900	6	HS 2 lbs	001624	22,90

Art.			EAN 4016671	EURO
325				
				
Schlosserhammer Engineers Hammer Marteau d'ajusteurs				
			ZN 82052000	PG 1
engl. Form, mit Kugel (Ingenieurhammer), mit Fiberglasstiel				
with ball peen, English pattern, with fibreglass-handle and rubber grip				
à boule modèle anglais, avec manche en fibre de verre poignée de caoutchouc				
0032500-0100	6	FS 1/4 lbs	001631	24,45
0032500-0225	6	FS 1/2 lbs	001648	25,40
0032500-0340	6	FS 3/4 lbs	001655	26,80
0032500-0450	6	FS 1 lbs	001662	30,30
0032500-0500	6	FS 1 1/8 lbs	001679	30,85
0032500-0600	6	FS 1 1/4 lbs	001686	32,05
0032500-0700	6	FS 1 1/2 lbs	001693	35,75
0032500-0800	6	FS 1 3/4 lbs	001709	37,35
0032500-0900	6	FS 2 lbs	001716	41,25

Art.			EAN 4016671	EURO
10				
				
Schlosserhammer Engineers Hammer Marteau d'ajusteurs				
			ZN 82052000	PG 1
engl. Form, mit Pinne (Ingenieurhammer)				
with cross peen, English pattern				
à pène, modèle anglais				
0001001-0100	6	ES 1/4 lbs	001723	11,45
0001001-0225	6	ES 1/2 lbs	001730	12,70
0001001-0340	6	ES 3/4 lbs	001747	13,15
0001001-0450	6	ES 1 lbs	001754	14,75
0001001-0500	6	ES 1 1/8 lbs	001761	15,50
0001001-0600	6	ES 1 1/4 lbs	001778	16,75
0001001-0700	6	ES 1 1/2 lbs	001785	18,35
0001001-0800	6	ES 1 3/4 lbs	001792	19,80
0001001-0900	6	ES 2 lbs	001808	21,70
0001002-0100	6	HS 1/4 lbs	001815	13,60
0001002-0225	6	HS 1/2 lbs	001822	14,75
0001002-0340	6	HS 3/4 lbs	001839	15,40
0001002-0450	6	HS 1 lbs	001846	16,90
0001002-0500	6	HS 1 1/8 lbs	001853	18,20
0001002-0600	6	HS 1 1/4 lbs	001860	19,85
0001002-0700	6	HS 1 1/2 lbs	001877	21,35
0001002-0800	6	HS 1 3/4 lbs	001884	22,90
0001002-0900	6	HS 2 lbs	001891	22,90

Art. EAN 4016671 EURO

326



Schlosserhammer
Engineers Hammer
Marteau d'ajusteurs

ZN 82052000 PG 1
engl. Form, mit Pinne (Ingenieurhammer), mit
Fiberglasstiel
with cross peen, English pattern, with
fiberglass-handle and rubber grip
à pène modèle anglais, avec manche en fibre
de verre poignée de caoutchouc

0032600-0100	6	FS 1/4 lbs	001907	24,45
0032600-0225	6	FS 1/2 lbs	001914	25,40
0032600-0340	6	FS 3/4 lbs	001921	26,80
0032600-0450	6	FS 1 lbs	001938	30,30
0032600-0500	6	FS 1 1/8 lbs	001945	30,85
0032600-0600	6	FS 1 1/4 lbs	001952	32,05
0032600-0700	6	FS 1 1/2 lbs	001969	35,75
0032600-0800	6	FS 1 3/4 lbs	001976	37,35
0032600-0900	6	FS 2 lbs	001983	41,25

16



Schlosserhammer
Locksmiths' Hammer
Marteau d'ajusteurs

ZN 82052000 PG 1
franz. Form
French pattern
modèle français

0001601-0200	12	ES	001990	11,60
0001601-0300	12	ES	002003	12,60
0001601-0400	12	ES	002010	13,85
0001601-0500	12	ES	002027	14,90
0001601-0800	6	ES	002034	20,05
0001601-1000	6	ES	002041	23,55
0001601-1500	6	ES	002058	31,40
0001601-2000	6	ES	002065	41,05

87a



Mechanikerhammer
Pattern Makers' Hammer
Petit marteau de mécaniciens

ZN 82052000 PG 1
engl. Form, mit Kugel
with ball peen
à boule

0008711	12	ES 100 g	005189	14,40
---------	----	----------	--------	-------

87b



Mechanikerhammer
Pattern Makers' Hammer
Petit marteau de mécaniciens

ZN 82052000 PG 1
engl. Form, mit Pinne
with cross peen
à pène

0008721	12	ES 100 g	005196	14,40
---------	----	----------	--------	-------

Art. EAN 4016671 EURO

88



Pinnhammer
Cross peen Hammer
Marteau avec pène

ZN 82052000 PG 1
dänische Form (Bankhammer)
Danish pattern
modèle danois

0008801-100	6	ES Gr. 0	005202	12,80
0008801-225	6	ES Gr. 1	005219	14,35
0008801-340	6	ES Gr. 2	005226	14,65
0008801-500	6	ES Gr. 3	005233	17,45
0008801-600	6	ES Gr. 4	005240	18,85

3 Klauenhämmer
Claw Hammers
Marteaux fendus

89



Klauenhammer
Claw Hammer
Marteau fendus

ZN 82052000 PG 1
franz. Form, mit eingelegten Federn
French pattern, with inlaid straps
modèle français, avec clavettes entaillées

0008901-22	12	ES 300 g	005257	22,45
------------	----	----------	--------	-------

92



Klauenhammer
Claw Hammer
Marteau fendus

ZN 82052000 PG 1
amerik. Form, mit Dülle, fein blank
American pattern, with socket, bright
polished
modèle américain, à douille, finement poli

0009201-23	6	ES 13 oz	005318	22,25
0009201-25	6	ES 16 oz	005325	22,75
0009201-27	6	ES 20 oz	005332	25,25
0009201-29	6	ES 24 oz	005349	29,30
0009202-23	6	HS 13 oz	005356	25,15
0009202-25	6	HS 16 oz	005363	25,15
0009202-27	6	HS 20 oz	005370	27,75
0009202-29	6	HS 24 oz	005387	32,95

Art.			EAN 4016671	EURO
92c				
			Klauehammer Claw Hammer Marteau fendu	
			ZN 82052000 PG 1	
			amerik. Form, mit Dülle, schwarz lackiert	
			American pattern, with socket, black finish	
			modèle américain, à douille, noir	
0009231-25	6	ES 16 oz	005394	20,45
0009231-27	6	ES 20 oz	005400	21,95
0009232-25	6	HS 16 oz	005424	22,70
0009232-27	6	HS 20 oz	005431	24,30

92MA				
			Klauehammer Claw Hammer Marteau fendu	
			ZN 82052000 PG 1	
			amerik. Form, magn. Nagelhalter, mit Dülle, fein blank	
			American pattern, with socket and magnetic nailholder, bright polished	
			modèle américain, à douille, avec porte-clou magnétique, finement poli	
0009251-27	6	ES 20 oz	005455	29,85

289				
			Klauehammer Claw Hammer Marteau fendu	
			ZN 82052000 PG 1	
			franz. Form, schwarzer Spezialgriff	
			with tubular steel shaft and special grip	
			avec manche en tube d'acier, poignée en plastique	
0028900	12	RS 600 g	009217	25,05

291				
			Klauehammer Claw Hammer Marteau fendu	
			ZN 82052000 PG 1	
			amerik. Form, Hals und Kopf rund, Durchm. 27 mm, Glockenform, schwarzer Spezialgriff	
			American pattern, with tubular steel shaft and special grip, polished, with round neck and round head	
			modèle américain, avec manche en tube d'acier et poignée en plastique, poli, avec cou rond et tête ronde	
0029100-13	6	RS 365 g	005516	22,15
0029100-16	6	RS 450 g	005523	23,20

Art.			EAN 4016671	EURO
891				
			Klauehammer "BlackGiant" Claw Hammer "BlackGiant" Marteau fendu "BlackGiant"	
			ZN 82052000 PG 1	
			amerik. Form, Hals und Kopf rund, Glockenform, 2-Komponenten-Griff orange/schwarz, zusätzliches Innenrohr, 16 oz.	
			American pattern, with tubular steel shaft and 2-components grip orange/black, polished, with round neck and round head, additional pipe inside	
			modèle américain, avec manche en tube d'acier et 2-composants poignée orange/noir, poli, avec cou rond et tête ronde, avec tube additionnel à l'intérieur	
0089100-16	12	RS 25 mm	020779	27,80
0089100-20	12	RS 27 mm	025224	30,10

292				
			Klauehammer Claw Hammer Marteau fendu	
			ZN 82052000 PG 1	
			amerik. Form, Hammerkopf fein blank, achtkt. Hals und runder Kopf, brauner Spezialgriff	
			American pattern, with tubular steel shaft and special grip, bright polished, with octagon neck and round head	
			modèle américain, avec manche en tube d'acier et poignée en plastique, finement poli, avec cou octogonal et tête ronde	
0029200-16	6	RS 25 mm	005530	29,60
0029200-20	6	RS 27 mm	005547	32,85

791				
			Klauehammer Claw Hammer Marteau fendu	
			ZN 82052000 PG 1	
			mit Ledergriff	
			with leather handle	
			avec manche en cuir	
0079100-13	4	13 oz.	023107	67,20
0079100-16	4	16 oz.	024142	69,70
0079100-20	4	20 oz.	024722	72,05
0079100-24	4	24 oz.	024739	72,75

591				
			Klauehammer Claw Hammer Marteau fendu	
			ZN 82052000 PG 1	
			mit 2-Komponenten-Griff rot/schwarz	
			with 2-components grip red/black	
			avec 2-composants poignée rouge/noir	
0059100-16	4	16 oz.	024586	54,20
0059100-20	4	20 oz.	024708	56,35
0059100-24	4	24 oz.	024715	57,70

Art.			EAN 4016671	EURO
293				
			Klauenhammer "Little Giant" Claw Hammer "Little Giant" Marteau fendu "Little Giant"	
			ZN 82052000	PG 1
			amerik. Form, Hammerkopf schwarz lackiert, schwarzer Spezialgriff	
			black finish, with tubular steel shaft and special grip	
			noir, avec manche en tube d'acier et poignée en plastique	
0029300	6	RS 10 oz / 20mm	005554	16,25

294				
			Klauenhammer Claw Hammer Marteau fendu	
			ZN 82052000	PG 1
			amerik. Form, fein blank, unverwüstit, mit Fiberglasstiel	
			American pattern, with fiberglass handle and rubber grip, bright polished	
			modèle américain, avec manche en fibre de verre, poignée en caoutchouc, finement poli	
0029400-16	6	FS 25 mm	005561	39,45

4 Werkzeuge für Schmiede und Hufschmiede Blacksmiths' and Farriers' Tools Outils de forge et de maréchal

1c				
			Schmiedehammer, kurze Form Blacksmith' Hammer Marteau de forgerons	
			ZN 82052000	PG 1
			handgeschmiedet	
			short pattern	
			modèle court	
0000131-1500	6	ES	011746	41,70

8a				
			Schmiedehammer Blacksmith' Hammer Marteau de forgerons	
			ZN 82052000	PG 1
			schwedische Form	
			Swedish pattern	
			modèle suédois	
0000811-1000	6	ES	001419	25,50
0000811-1500	6	ES	001426	34,35
0000812-1000	6	HS	001433	27,80
0000812-1500	6	HS	001440	36,85

Art.			EAN 4016671	EURO
18				
			Rundgesenk-Oberteil Top Swage Etampe	
			ZN 82052000	PG 1
0001800-10	1	OS 800 g	002072	71,85
0001800-15	1	OS 1150 g	002089	71,85
0001800-20	1	OS 1700 g	002096	71,85
0001800-25	1	OS 1750 g	002102	71,85
0001801-10	1	ES 800 g	002119	82,10
0001801-15	1	ES 1150 g	002126	82,10
0001801-20	1	ES 1700 g	002133	82,10
0001801-25	1	ES 1750 g	002140	82,10

19				
			Rundgesenk-Unterteil Bottom Swage Sous Etampe	
			ZN 82052000	PG 1
			Stiftstärke 25 mm	
			pin-end 25 mm	
			pointe de 25 mm	
0001900-10	1	1150 g	002157	71,85
0001900-15	1	1150 g	002164	71,85
0001900-20	1	1150 g	002171	71,85
0001900-25	1	1150 g	002188	71,85

20				
			Setzhammer-Oberteil Set Hammer Chasse carrée	
			ZN 82052000	PG 1
0002000-50	1	OS 2100 g	002201	71,85
0002001-50	1	ES 2100 g	002225	82,85

21				
			Setzhammer-Unterteil Bottom Hammer Tas à planer	
			ZN 82052000	PG 1
			Stiftstärke 25 mm	
			pin-end 25 mm	
			pointe de 25 mm	
0002100-50	1	1050 g	002249	71,85

22				
			Schlichthammer Square Flatter Chasse à parer	
			ZN 82052000	PG 1
0002200-60	1	OS 1500 g	002256	69,65
0002200-70	1	OS 2050 g	002263	91,75
0002201-60	1	ES 1500 g	002287	84,40
0002201-70	1	ES 2050 g	002294	106,50

Art.			EAN 4016671	EURO
23				
			Ballhammer-Oberteil Top Fuller Etampe à dégorger	
			ZN 82052000	PG 1
0002300-05	1	OS 1150 g	002317	45,90
0002300-10	1	OS 1150 g	002324	45,90
0002300-15	1	OS 1150 g	002331	61,90
0002300-20	1	OS 1150 g	002348	61,90
0002301-05	1	ES 1150 g	002355	57,90
0002301-10	1	ES 1150 g	002362	57,90
0002301-15	1	ES 1150 g	002379	72,45
0002301-20	1	ES 1150 g	002386	72,45

Art.			EAN 4016671	EURO
24				
			Ballhammer-Unterteil Bottom Fuller Sous Etampe à dégorger	
			ZN 82052000	PG 1
			Stiftstärke 25 mm	
			pin-end 25 mm	
			pointe de 25 mm	
0002400-05	1	800 g	002393	45,90
0002400-10	1	800 g	002409	45,90
0002400-15	1	800 g	002416	61,90
0002400-20	1	1150 g	002423	61,90

Art.			EAN 4016671	EURO
25				
			Stieldurchschlag Drifts or punches, round Poinçon rond pour forgerons	
			ZN 82052000	PG 1
			Lochhammer, rund	
0002500-08	1	OS 635 g	002430	50,45
0002500-10	1	OS 950 g	002447	50,45
0002500-12	1	OS 950 g	002454	65,85
0002500-15	1	OS 1100 g	002461	65,85
0002500-18	1	OS 1400 g	002478	80,25
0002500-20	1	OS 1400 g	002485	80,25
0002500-25	1	OS 1800 g	002492	94,40
0002501-08	1	ES 635 g	002508	56,80
0002501-10	1	ES 950 g	002515	56,80
0002501-12	1	ES 950 g	002522	74,45
0002501-15	1	ES 1100 g	002539	74,45
0002501-18	1	ES 1400 g	002546	89,10
0002501-20	1	ES 1400 g	002553	89,10
0002501-25	1	ES 1800 g	002560	105,60

Art.			EAN 4016671	EURO
26				
			Stieldurchschlag Drifts or punches, square Poinçon carrée pour forgerons	
			ZN 82052000	PG 1
			Lochhammer, kántig	
0002600-10	1	OS 950 g	002577	60,45
0002600-15	1	OS 1200 g	002584	78,40
0002600-20	1	OS 1500 g	002591	95,65
0002601-10	1	ES 950 g	002607	67,65
0002601-15	1	ES 1200 g	002614	88,35
0002601-20	1	ES 1500 g	002621	105,30

Art.			EAN 4016671	EURO
27				
			Ambosshorn Anvil beak Sous Etampe conique à élargir	
			ZN 82058000	PG 1
			DIN 7441, Stiftstärke 25 mm	
			pin-end 25 mm	
			pointe de 25 mm	
0002700	1	1100 g	002638	51,10

Art.			EAN 4016671	EURO
28				
			Ambossschroter Hardie Sous Etampe à trancher	
			ZN 82058000	PG 1
			DIN 7442, Stiftstärke 25 mm, Schneidbreite 50 mm	
0002800	1	1100 g	002645	51,10

Art.			EAN 4016671	EURO
30				
			Hufschmiedehammer Farriers' Hammer Marteau à planer pour forgerons	
			ZN 82052000	PG 1
0003001-1100	6	ES	002690	68,30
0003001-1500	6	ES	002706	79,70

Art.			EAN 4016671	EURO
30a				
			Hufhammer Shoeing Hammer Marteau de maréchaux	
			ZN 82052000	PG 1
			deutsche Form, ganz blank, Holzstiel mit Federn	
			polished, German pattern, handle with straps	
			forme allemande, avec manche à clavette	
0003011-350	6	ES	002713	46,85
0003011-500	6	ES	013283	56,10
0003012-350	6	HS	002720	49,45
0003012-500	6	HS	013290	58,75
0003030-350	6	Fiberglasstiel	013320	73,80
0003030-500	6	Fiberglasstiel	025750	80,40

Art.			EAN 4016671	EURO
30b	 <p>Hufhammer Shoeing Hammer Marteau de maréchaux</p> <p>ZN 82052000 PG 1</p> <p>engl. Form English pattern forme anglaise</p>			
0003021	6	ES 350 g	002737	16,05

Art.			EAN 4016671	EURO
31	 <p>Kaltschrotmeißel Cold cutting Chisel Tranche à froid</p> <p>ZN 82052000 PG 1</p> <p>DIN 5107, aus Meißelstahl</p>			
0003100-1000	1	OS	002744	36,55
0003100-1500	1	OS	002768	47,00
0003101-1000	1	ES	002775	45,85
0003101-1500	1	ES	002799	56,00

Art.			EAN 4016671	EURO
32	 <p>Warmeschrotmeißel Hot cutting Chisel Tranche à chaud</p> <p>ZN 82052000 PG 1</p> <p>DIN 5107, aus Meißelstahl</p>			
0003200-1000	1	OS	002805	36,55
0003200-1500	1	OS	002829	47,00
0003201-1000	1	ES	002836	45,85
0003201-1500	1	ES	002850	56,00

Art.			EAN 4016671	EURO
33	 <p>Nietenquetscher Side chisel Tranche à deriver</p> <p>ZN 82052000 PG 1</p> <p>aus Meißelstahl (for rivets)</p>			
0003300-1500	1	OS	002867	52,75
0003301-1500	1	ES	002874	63,35

Art.			EAN 4016671	EURO
34	 <p>Kaltschrotmeißel Cold cutting Chisel Tranche à froid</p> <p>ZN 82052000 PG 1</p> <p>wolfram-legiert, für höchste Ansprüche from tungsten alloyed steel, for high demands de qualité extrême</p>			
0003400-1500	1	OS	002881	93,25
0003401-1500	1	ES	002898	101,75

Art.			EAN 4016671	EURO
35	 <p>Warmeschrotmeißel Hot cutting Chisel Tranche à chaud</p> <p>ZN 82052000 PG 1</p> <p>wolfram-legiert, für höchste Ansprüche from tungsten alloyed steel, for high demands de qualité extrême</p>			
0003500-1500	1	OS	002904	93,25
0003501-1500	1	ES	002911	101,75

Art.			EAN 4016671	EURO
47	 <p>Flachmaul-Schmiedezange Blacksmiths' Tong, flat nosed Tenaille de forge, becs plats</p> <p>ZN 82032000 PG 1</p>			
0004700-300	1	500 g	003345	18,90
0004700-400	1	750 g	003352	24,90
0004700-500	1	1200 g	003369	31,45
0004700-600	1	1600 g	003376	43,00

Art.			EAN 4016671	EURO
47a	 <p>Schoßmaul-Schmiedezange Blacksmiths' Tong Tenaille de forge, à bec plat, coquille carrée</p> <p>ZN 82032000 PG 1</p>			
0004710-500	1	1250 g	003383	40,25

Art.			EAN 4016671	EURO
48	 <p>Rundmaul-Schmiedezange Blacksmiths' Tong, round nosed Tenaille de forge, becs ronds</p> <p>ZN 82032000 PG 1</p>			
0004800-300	1	500 g	003390	20,80
0004800-400	1	750 g	003406	26,85
0004800-500	1	1200 g	003413	32,55
0004800-600	1	1650 g	003420	43,95

Art.			EAN 4016671	EURO
49	 <p>Wolfsmaul-Schmiedezange Blacksmiths' Tong, wolf's jaw Tenaille de forge, becs gueule de loup</p> <p>ZN 82032000 PG 1</p>			
0004900-300	1	500 g	003437	29,40
0004900-400	1	850 g	003444	34,70
0004900-500	1	1200 g	003451	40,20
0004900-600	1	1700 g	003468	54,85

Art.			EAN 4016671	EURO
49a				
Nietzange Rivetting Tong Tenaille de forge pour rivets				
			ZN 82032000	PG 1
0004910-400	1	500 g	003475	24,90
0004910-500	1	850 g	003482	31,40
0004910-600	1	1300 g	003499	43,00

49b				
Döpperzange Blacksmiths' Tong Tenaille de forge pour bouterolles				
			ZN 82032000	PG 1
0004920-400	1	750 g	003505	30,25
0004920-500	1	1200 g	003512	37,85
0004920-600	1	1700 g	003529	49,70

49c				
Dornzange Blacksmiths' Tong Tenaille de forge				
			ZN 82032000	PG 1
0004930-300	1	500 g	003536	20,70
0004930-400	1	750 g	003543	26,85
0004930-500	1	1200 g	003550	32,05
0004930-600	1	1700 g	003567	44,05

5 Brechstangen Crow Bars Pincen en acier

45				
Brechstange Crow Bar Pince en acier				
			ZN 82055980	PG 1
vierkant, gebrochene Kanten, mit Spitze und aufgebogener Schneide				
shaft with chamfered edges, with edge and point				
à chanfrein, avec taillant courbé et pointe				
0004500-100	1	5,0 kg	003017	60,25
0004500-125	1	7,0 kg	003024	76,20
0004500-150	1	10,0 kg	003031	85,40
0004500-175	1	11,0 kg	003048	108,30
0004500-200	1	13,0 kg	003055	126,60

Art.			EAN 4016671	EURO
45N				
Brechstange Crow Bar Pince en acier				
			ZN 82055980	PG 1
norwegische Form				
special pattern				
modèle speciale				
0004550-105	1	4,5 kg	013382	60,25
0004550-120	1	5,0 kg	013399	64,40
0004550-135	1	6,0 kg	013405	70,75
0004550-150	1	7,0 kg	013412	78,50
0004550-160	1	8,0 kg	013429	86,80

46				
Brechstange Crow Bar Pince en acier				
			ZN 82055980	PG 1
rund, Durchm. 30 mm, gerade Schneide und Spitze				
with point and flat edge				
à pointe et taillant				
0004600-100	1	4,5 kg	003062	24,50
0004600-125	1	6,5 kg	003079	29,65
0004600-150	1	8,0 kg	003086	35,35
0004600-175	1	9,5 kg	003093	45,05
0004600-200	1	11,0 kg	003109	60,75

46a				
Brechstange Crow Bar Pince en acier				
			ZN 82055980	PG 1
rund, Durchm. 30 mm, aufgebogene Schneide und Spitze				
with point and flat curved edge				
à pointe et taillant courbé				
0004610-100	1	4,5 kg	003116	24,50
0004610-125	1	6,5 kg	003123	29,65
0004610-150	1	8,0 kg	003130	35,35
0004610-175	1	9,5 kg	003147	45,05
0004610-200	1	11,0 kg	003154	60,75

46b				
Brechstange Carpenters' Pinching-bar Barre à mine - Arrache clou				
			ZN 82055980	PG 1
rund, Durchm. 30 mm, mit Klaue und Spitze				
0004620-100	1	4,5 kg	003161	26,30
0004620-125	1	6,5 kg	003178	31,35
0004620-150	1	8,0 kg	003185	37,20
0004620-175	1	9,5 kg	003192	47,55
0004620-200	1	11,0 kg	003208	63,05

Art.			EAN 4016671	EURO
46c				
Pflasterbrechstange Crow Bar for pavers Pince en acier pour paveur				
			ZN 82055980	PG 1
mit Schneide und Kugelkopf Durchm. 70 mm				
0004630-100	1	5,5 kg	003215	46,30
0004630-125	1	7,0 kg	003222	48,15
0004630-150	1	8,5 kg	003239	58,55

46e				
Pflasterbrechstange Crow Bar for pavers Pince en acier pour paveur				
			ZN 82055980	PG 1
rund, Durchm. 30 mm, mit Spitze und Kugelkopf Durchm. 70 mm				
0004650-100	1	5,5 kg	003291	46,30
0004650-125	1	7,0 kg	003307	48,15
0004650-150	1	8,5 kg	003314	58,55

555				
Pflasterbrechstange Crow Bar for pavers Pince en acier				
			ZN 82055980	PG 1
Hamburger Modell, Schneide 32 mm				
Hamburg pattern				
modèle Hamburg				
0055500-125	1	7,0 kg	015607	99,05
0055500-150	1	8,5 kg	015614	114,40

560				
Pflasterbrechstange Crow Bar for pavers Pince en acier				
			ZN 82055980	PG 1
Kopfdurchm. 70 mm				
head 70 mm				
tête 70 mm				
0056000-08	1	125 cm	015621	99,05
0056000-10	1	150 cm	015638	114,40

46f				
Rollbrechstange mit Eisenrollen Pinching Bar with iron rollers Barre à mine avec 2 roulettes en fer				
			ZN 82055980	PG 1
Tragfähigkeit 3000 kg				
capacity 3000 kg				
force 3000 kg				
0004660	1	14 kg / 160 cm	003321	255,25

Art.			EAN 4016671	EURO
46g				
Rollbrechstange mit Gummirollen Pinching Bar with rubber rollers Barre à mine avec 2 roulettes en caoutchouc				
			ZN 82055980	PG 1
Tragfähigkeit 3000 kg				
capacity 3000 kg				
force 3000 kg				
0004670	1	14 kg / 160 cm	003338	304,30

46d				
Brechstange (Kuhfuß) Carpenters' Pinching-bar Barre à mine - Arrache clou				
			ZN 82055980	PG 2
Hamburger Form, Nagelisen für Zimmerleute, stabile, runde Ausführung				
0004640-050	1	19 mm / 1,4 kg	003246	14,35
0004640-060	1	20 mm / 1,7 kg	003253	15,70
0004640-070	1	21 mm / 1,9 kg	003260	18,15
0004640-080	1	22 mm / 2,5 kg	003277	18,60
0004640-100	1	25 mm / 4,0 kg	003284	30,35

46h				
Montage- und Hebeisen Pinching Bar for construction work Levier avec taillant pour montage				
			ZN 82055980	PG 2
für Montagearbeiten, Stahlbau, Holzarbeiten usw. bestens geeignet. Handliche, besonders stabile und kräftige Ausführung, Schneide 50 mm				
extra strong				
0004681-50	1	50 cm	013467	37,00
0004681-70	1	70 cm	013474	39,75

519				
Kuhfuß Base Moulding Lifter Arrache-clou, spécial				
			ZN 82055980	PG 1
verchromt				
chrome-plated				
chromés				
0051900	12	250 g, 270mm	008470	12,75

**6 Werkzeuge für Pflasterer, Maurer und Steinbearbeitung, Garten- und Landschaftsbau
Pavers', Bricklayers', Stone Working and Landscape gardener Tools
Outils de paveur, de maçon**

Art. EAN 4016671 EURO

59



**Steinspalthammer
Stone Sledge
Masse à rompre**

ZN 82052000 PG 1
mit ovalem Loch, leicht gewölbte Bahn
with oval eye and slightly curved face
pour carriers avec trou ovale

0005901-03	1	ES	004168	36,10
0005901-04	1	ES	004175	42,95
0005901-05	1	ES	004182	51,25
0005901-06	1	ES	004199	63,30

59 1/2



**Steinspalthammer
Stone Sledge
Masse à rompre**

ZN 82052000 PG 1
mit ovalem Loch, leicht gewölbte Bahn,
scharfkantig
with oval eye and slightly curved face, sharp
edged
pour carriers avec trou ovale, à coins rifs

0005991-1000	6	ES	004243	22,45
0005991-1250	6	ES	004250	26,10
0005991-1500	6	ES	004267	27,95

60



**Steinspalthammer
Stone Sledge
Masse à rompre**

ZN 82052000 PG 1
mit ovalem Loch, Spezialform
special pattern, with oval eye
pour carriers avec trou ovale

0006001-03	1	ES	013627	43,25
0006001-04	1	ES	013634	51,60
0006001-05	1	ES	013641	61,75

64



**Bossierhammer
Embossing Hammer
Marteau de paveur**

ZN 82052000 PG 1
Spezialstahl, mit geraden Bahnen und
ovalem Loch
with oval eye, straight faces
avec trou ovale, faces droites

0006401-1000	6	ES	021844	25,00
0006401-1500	6	ES	004298	29,35
0006401-2000	6	ES	004304	37,85

Art. EAN 4016671 EURO

65



**Bossierhammer
Embossing Hammer
Marteau de paveur**

ZN 82052000 PG 1
Spezialstahl, mit zwei hohlen Bahnen und
ovalem Loch
with oval eye, concave faces
avec trou ovale, faces creux

0006501-1500	6	ES	004311	54,20
0006501-2000	6	ES	004328	68,20

66



**Charierhammer
Bush Hammer
Boucharde**

ZN 82052000 PG 1

0006601-1000	1	ES	004335	57,85
0006601-1500	1	ES	004342	86,00
0006601-2000	1	ES	004359	97,40

66a



**Stockhammer-Einsatz
Loose Dies for Bush Hammers
Frappe à boucharder**

ZN 82052000 PG 1
40 x 40 mm

0006610-5X5	1	150 g	004366	17,80
0006610-6X6	1	150 g	004373	17,80
0006610-7X7	1	150 g	004380	17,80
0006610-8X8	1	150 g	004397	17,80

66b



**Stockhammer
Bush Hammer
Marteau à boucharder**

ZN 82052000 PG 1
für Einsätze 66a passend, 40 x 40 mm
for loose dies 66a, 40 x 40 mm
à frappe interchangeable 66a, 40 x 40 mm

0006621	1	ES 1800 g	004403	75,35
---------	---	-----------	--------	-------

67



**Chariereisen
Bush Chisel
Ciseau à boucharder**

ZN 82055910 PG 1

0006700-060	1	650 g	004410	18,90
0006700-080	1	850 g	004427	24,70
0006700-100	1	1100 g	004434	30,45
0006700-120	1	1225 g	004441	34,40

Art.			EAN 4016671	EURO
67a	 <p>Chariereisen Bush Chisel Ciseau à boucherer</p> <p>ZN 82055910 PG 1</p> <p>gezahnt with teeth avec dents</p>			
0006710-060	1	650 g	004458	31,05
0006710-080	1	850 g	004465	38,95
0006710-100	1	1100 g	004472	52,15

67b	 <p>Prelleisen Bush Chisel with edge Hasse à brique</p> <p>ZN 82055910 PG 1</p>			
0006720-060	1	650 g	004489	25,25
0006720-080	1	850 g	004496	32,30
0006720-100	1	1100 g	004502	40,00

68	 <p>Pflasterhammer Pavers' Hammer Marteau de paveur</p> <p>ZN 82052000 PG 1</p> <p>Berliner Form Berlin pattern modèle Berlin</p>			
0006801-1000	1	ES	004519	44,35
0006801-1500	1	ES	004526	46,70
0006801-2000	1	ES	004533	48,75
0006801-2500	1	ES	004540	50,90
0099068-1000	1	Ersatzstiel	023015	4,55
0099068-1500	1	Ersatzstiel	023022	4,55
0099068-2000	1	Ersatzstiel	023039	4,55

68b	 <p>Pflasterhammer Pavers' Hammer Marteau de paveur</p> <p>ZN 82052000 PG 1</p> <p>rheinische Form Rhineland pattern mod. rhénan</p>			
0006821-1500	1	ES	004588	54,85
0006821-2000	1	ES	004595	61,50
0006821-2500	1	ES	004601	66,90
0006821-3000	1	ES	004618	73,25

Art.			EAN 4016671	EURO
68e	 <p>Plattenlegerhammer Hammer for pavers Marteau pour paveur</p> <p>ZN 82052000 PG 1</p> <p>mit aufvulkanisiertem Gummiklotz 100 x 95 mm with rubber face 100 x 95 mm avec face quatre 100 x 95 mm de caoutchouc</p>			
0006851	1	ES	013740	56,70

68 1/2	 <p>Plattenlegerhammer Hammer for pavers Marteau pour paveur</p> <p>ZN 82052000 PG 1</p> <p>mit rundem Gummieinsatz, Durchmesser 110 mm with round rubber face 110 mm avec face rond de caoutchouc 110 mm</p>			
0006891-1500	1	ES	004656	56,85

75	 <p>Maurerhammer, DIN 5108 Masons' Hammer Marteau de maçon</p> <p>ZN 82052000 PG 1</p> <p>rheinische Form Rhineland pattern modèle rhénan</p>			
0007500-500	12	OS	004809	7,65
0007500-600	12	OS	004816	7,90
0007500-800	1	OS	004823	16,40
0007501-500	12	ES	004830	9,10
0007501-600	12	ES	004847	9,40
0007501-800	1	ES	004854	18,25
0099075-500	1	Stiel 300 mm	018912	1,90
0099075-600	1	Stiel 300 mm	018929	1,90
0099075-800	1	Stiel 340 mm	018936	2,40

77	 <p>Maurerhammer Masons' Hammer Marteau de maçon</p> <p>ZN 82052000 PG 1</p> <p>Berliner Form Berlin pattern modèle Berlin</p>			
0007701-600	12	ES	004885	22,75

Art.			EAN 4016671	EURO
80b				
				
Maurerhammer Masons' Hammer Marteau de maçon				
			ZN 82052000	PG 1
			Münchner Form	
			Munich pattern	
			modèle Munich	
0008021-600	1	ES geraut	004915	22,80

Art.			EAN 4016671	EURO
81				
				
Bruchsteinhammer Stone Breakers' Hammer Marteau de carriers				
			ZN 82052000	PG 1
			mit rundem Loch	
			with round eye	
			avec oeil rond	
0008100-1000	1	OS	004922	35,80
0008100-1500	1	OS	004939	44,65
0008100-2000	1	OS	004946	53,05

Art.			EAN 4016671	EURO
81a				
				
Maurerhammer Masons' Hammer Marteau de maçon				
			ZN 82052000	PG 1
			amerik. Form	
			American pattern	
			modèle américain	
0008111	12	ES 800 g	004953	24,30

Art.			EAN 4016671	EURO
82				
				
Maurerhammer Masons' Hammer Marteau de maçon				
			ZN 82052000	PG 1
			holländische Form	
			Dutch pattern	
			modèle hollandais	
0008201-500	12	ES	004960	18,20
0008201-750	12	ES	004977	21,55

Art.			EAN 4016671	EURO
510				
				
Plattenlegerramme Pavers' beetle Demoiselle d'acier				
			ZN 82052000	PG 1
			mit Kunststoffpuppe	
			with special plastic body	
			avec corps en plastique	
0051000	1	3000 g	015423	85,15

Art.			EAN 4016671	EURO
515				
				
Plattenlegerramme Pavers' beetle Demoiselle d'acier				
			ZN 82055980	PG 1
			mit Holzpuppe und Beschlagring	
			with wooden body and metal fitting	
			avec corps en bois et socle conique	
0051500	1	3000 g	015430	59,40

Art.			EAN 4016671	EURO
535				
				
Pflasterramme Pavers' beetle Demoiselle d'acier				
			ZN 82055980	PG 1
			ohne Griff	
			without grip	
			sans coup de main	
0053500-15000	1	15 kg	015546	252,60
0053500-20000	1	20 kg	015553	279,40
0053500-25000	1	25 kg	015560	337,70
0099535	1	Holzgriff	019513	8,35

Art.			EAN 4016671	EURO
550 / 551				
				
Betonstampfer Concrete rammer Pilon à béton				
			ZN 82019000	PG 1
			mit T-Griff, Länge 740 mm, Grundplatte 200 x 200 mm, ohne oder mit Schwingungselement	
0055000	1		015591	53,00
0055100	1	Schwingungselement	025965	95,75

Art.			EAN 4016671	EURO
552 / 553				
				
Betonstampfer Concrete rammer Pilon à béton				
			ZN 82019000	PG 1
			gerader Griff, Länge 1000 mm, Grundplatte 200 x 200 mm, ohne oder mit Schwingungselement	
0055200	1		025972	53,00
0055300	1	Schwingungselement	025989	95,75

Art.			EAN 4016671	EURO
565				
				
Bordsteinzange Kerbstone tong Porte-tenaille				
			ZN 82055980	PG 1
			pulverbeschichtet, mit Gummigriffen, zum Setzen von Bordsteinen, Randsteinen, Rinnensteinen usw.	
			with rubber grips	
			pour bords, avec coups de main en caoutchouc	
0056500	1	4,5 kg	015645	84,45
0056590	1	Ersatzgummi	021479	8,20

Art.			EAN 4016671	EURO
566			Treppenstufen-Versetzzange	
			ZN 82055980 PG 1	
			Universalzange zum Setzen von Stufen. Tragegriffe zum Transport abnehmbar.	
0056600		1	025996	143,65

Art.			EAN 4016671	EURO
579			Erdnagelzieher	
			ZN 82055980 PG 1	
			Zum einfachen, zeitsparenden Herausziehen von Erdnägeln (Pinnen)	
0057900		1	026047	24,85

Art.			EAN 4016671	EURO
567			Versetzzange	
			ZN 82055980 PG 1	
			ohne Öse, Zum Versetzen / Verlegen von Bordsteinen und Gehwegplatten, längsgreifend. Tragegriffe zum Transport abnehmbar.	
0056700		1	026009	218,20

Art.			EAN 4016671	EURO
660			Gärtnerspaten mit T-Griff	
			Spade	
			Bêche	
			ZN 82011000 PG 1	
			280 x 180 mm, massiver Fiberglas-Stiel aus gleichmäßig und parallel gezogener 100%iger TCP-Glasfaser, 10 x widerstandsfähiger als Holz, unempfindlich gegen Temperatur- und Feuchtigkeitsschwankungen, Doppelfeder mit Verstärkungsring, 2 robuste Fußtritte, gehärtetes Blatt, Blattstärke 3,5 mm, angeschmiedete selbstschärfende Schneide	
0066000		1 FS	026337	172,35

Art.			EAN 4016671	EURO
568			Randsteinheber	
			ZN 82055980 PG 1	
			Zum Setzen von Rand- und Leistensteinen. Für Naturrandsteine geeignet.	
0056800		1	026016	34,50

Art.			EAN 4016671	EURO
662			Rodespaten mit T-Griff	
			Spade	
			Bêche	
			ZN 82011000 PG 1	
			350 x 130 mm, massiver Fiberglas-Stiel aus gleichmäßig und parallel gezogener 100%iger TCP-Glasfaser, 10 x widerstandsfähiger als Holz, unempfindlich gegen Temperatur- und Feuchtigkeitsschwankungen, Doppelfeder mit Verstärkungsring, 2 robuste Fußtritte, gehärtetes Blatt, Blattstärke 3,5 mm, angeschmiedete selbstschärfende Schneide	
0066200		1 FS	026344	158,55

Art.			EAN 4016671	EURO
570			Pflastersteinzange	
			Tong for paving stones	
			Pince pour paveurs	
			ZN 82055980 PG 1	
0057000		1 700 mm / 5kg	015652	112,75

Art.			EAN 4016671	EURO
670 / 670a			Gärtnerspaten	
			Spade	
			Bêche	
			ZN 82011000 PG 1	
			285 x 180 mm, Stiel mit Glasfaserkern aus gleichmäßig und parallel gezogener Glasfaser und Polypropylenummantelung, viel widerstandsfähiger als Holz, 2 robuste Fußtritte, gehärtetes Blatt, Blattstärke 3 mm, angeschmiedete selbstschärfende Schneide	
0067000		1 FS mit T-Griff	026351	109,05
0067010		1 FS mit Knopfstiel	026368	109,05

Art.			EAN 4016671	EURO
571			Verbundsteinzieher	
			ZN 82055980 PG 1	
			Zum Herausnehmen von Verbund- und anderen Pflastersteinen, stufenlos verstellbar, Federstahlklingen auswechselbar	
0057100		1	026023	100,25
0057190		1 Ersatzklinge	026443	10,40

Art.			EAN 4016671	EURO
572			Richteisen	
			ZN 82055980 PG 1	
			Zum Nachrichten bereits verlegter Verbundsteine bzw. Gehwegplatten, Federstahlklinge auswechselbar	
0057200		1	026030	62,35
0057290		1 Ersatzklinge	026450	10,50

Art.			EAN 4016671	EURO
673				
			Drainagespaten mit T-Griff Spade Bêche	
			ZN 82011000	PG 1
			380 x 140 mm, Stiel mit Glasfaserkern aus gleichmäßig und parallel gezogener Glasfaser und Polypropylenummantelung, viel widerstandsfähiger als Holz, 2 robuste Fußtritte, gehärtetes Blatt, Blattstärke 3 mm, angeschmiedete selbstschärfende Schneide	
0067300	1	FS	026375	104,60

680				
			Frankfurter Schaufel Frankfurter Shovel Pelle Alsace	
			ZN 82011000	PG 1
			300 x 270 mm, gehärtetes Blatt, Schneide angeschliffen, glasfaserverstärkter Polyamid-Stiel, Stiel 1300 x 41 mm, Form nach DIN 20151	
0068000	1	FS	026382	30,80

681 / 681a				
			Holsteiner Schaufel Holsteiner Shovel Pelle	
			ZN 82011000	PG 1
			270 x 250 mm, gehärtetes Blatt, Schneide angeschliffen, glasfaserverstärkter Polyamid-Stiel, Stiel 1300 x 41 mm, Form nach DIN 20151 oder mit T-Griff	
0068100	1	FS	026399	29,45
0068110	1	mit T-Griff	026467	29,45

682				
			Holländer Schaufel Dutch Shovel Pelle	
			ZN 82011000	PG 1
			290 x 240 mm, gehärtetes Blatt, Schneide angeschliffen, glasfaserverstärkter Polyamid-Stiel, Stiel 1300 x 41 mm, Form nach DIN 20151	
0068200	1	FS	026405	29,45

685				
			Grabeschaukel "Foxpoint" Shovel Pelle	
			ZN 82011000	PG 1
			225 x 330 mm, gehärtet, Materialstärke 2 mm, mit Fußtritten und geschlossener hinteren Rille, mit Glasfaserstiel 32 mm, Gesamtlänge 1500 mm	
0068500	1	FS	026412	50,15

Art.			EAN 4016671	EURO
688				
			Hallenser Randschaufel Shovel Pelle	
			ZN 82011000	PG 1
			mit Stahlkante, 380 x 380 mm, T-Stiel aus glasfaserverstärktem Kunststoff, bis zu 3 x widerstandsfähiger als Holz, Stiel 1100 x 39 mm	
0068800	1	FS Gr. 9	026429	44,90

689				
			Grabegabel / Spatengabel Spading Fork Fourche Bêche	
			ZN 82012000	PG 1
			280 x 180 mm, mit 4 Zinken, geschmiedet, gehärtet, T-Stiel aus glasfaserverstärktem Kunststoff, bis zu 3 x widerstandsfähiger als Holz, Stiel 950 x 39 mm	
0068900	1	FS	026436	40,40

74050				
			Schneeräumer / Schneeschaukel Snow shovel	
			ZN 44170000	PG 2
			aus Leichtmetall, 350 x 500 mm mit Schutzkante, Klemmfix-Befestigung, mit 130 cm Buchenstiel	
			made of aluminium, with reinforcing ribs, at the bottom side with edge for protection, wooden handle (not assembled)	
0074050-000	10	neu!	026603	35,60

74060				
			Schneeräumer / Schneeschaukel Snow shovel	
			ZN 82019000	PG 2
			aus 5-schichtigem Sperrholz, 350 x 500 mm mit Schutzkante, Klemmfix-Befestigung, mit 130 cm Buchenstiel	
			made of quality plywood, at the bottom side with edge for protection, wooden handle (not assembled)	
0074060-000	10	neu!	026610	23,15

**7 Werkzeuge für Polsterer, Dekorateure und Bodenleger
Upholsterers', Decorators' and Carpet Layers' Tools
Outils de décorateur et de tapicier**

Art.   EAN 4016671 EURO

83



**Fliesenlegerhammer
Hammer for Flaglayers
Marteau de carreleurs**

ZN 82052000 PG 1
aus Spezialstahl, mit Querpinne

0008301 12 ES 80 g 004984 9,35

83hW



**Fliesenlegerhammer
Hammer for Flaglayers
Marteau de carreleurs**

ZN 82052000 PG 1
mit Hartmetallspitze
point made from special steel (hard metal)
pointe de métal spécial (métal dur)

0008341 12 ES 50 g 005011 16,40

83W



**Fliesenlegerhammer
Hammer for Flaglayers
Marteau de carreleurs**

ZN 82052000 PG 1
mit Hartmetallschneide
cut made from special steel (hard metal)
tranche de métal spécial (métal dur)

0008371 12 ES 50 g 005004 15,65

83h



**Fliesenlegerhammer
Hammer for Flaglayers
Marteau de carreleurs**

ZN 82052000 PG 1
mit Spitze
with point
avec pointe

0008381 12 ES 80 g 004991 9,35

83 1/2



**Fliesenlegerhammer
Hammer for Flaglayers
Marteau de carreleurs**

ZN 82052000 PG 1
ergonomisch geformter 2-Komponenten-Griff, innenliegender Fiberglasstiel, Aufhängeöse am Griffende, mit integrierter Hartmetallspitze
point made from special steel (hard metal)
pointe de métal spécial (métal dur)

0008390 1 FS neu! 025934 10,30

Art.   EAN 4016671 EURO

91a



**Magnethammer
Magnetic Hammer
Marteau magnétiques**

ZN 82052000 PG 1
mit Dauermagnet, Klaue, fein blank
with permanent magnet and claw, bright polished, force of magnet not diminishing
avec aimant permanent et fendus, poli, ce marteau ne perd pas sa force magnétique

0009111 12 ES 210 g 005288 26,30

91c



**Magnethammer
Magnetic Hammer
Marteau magnétiques**

ZN 82052000 PG 1
mit Dauermagnet, fein blank
with permanent magnet, bright polished, force of magnet not diminishing
avec aimant permanent, poli, ce marteau ne perd pas sa force magnétique

0009131 12 ES 220 g 005295 31,85

91d



**Magnethammer
Magnetic Hammer
Marteau magnétiques**

ZN 82052000 PG 1
mit Dauermagnet, verchromt
with permanent magnet, chrome plated, force of magnet not diminishing
avec aimant permanent, chromé, ce marteau ne perd pas sa force magnétique

0009141 12 ES 130 g 005301 24,75

214



**Glaserhammer
Glaziers' Hammer
Marteau de vitriers**

ZN 82052000 PG 1
fein blank
polished
poli

0021401 12 ES 170 g 008234 22,35

Art. EAN 4016671 EURO

216 / 216a



Polsterhammer
Hammer for upholsterers
Marteau de tapiciers

ZN 82052000 PG 1

fein blank, mit gerilltem rundem Stiel, mit umliegender Feder, ohne oder mit Dauermagnet

polished, with annulated round handle and salient strap around, also with permanent magnet

poli, avec manche rond rainuré à clavettes / avec aimant permanent

0021601-10	12	ES	008241	33,55
0021601-12	12	ES	008258	33,55
0021601-14	12	ES	008265	33,55
0021601-16	12	ES	008272	33,55
0021611-10	12	ES mit Magnet	008289	40,95
0021611-12	12	ES mit Magnet	008296	40,95
0021611-14	12	ES mit Magnet	008302	40,95

217 / 217a



Polsterhammer
Hammer for upholsterers
Marteau de garnisseurs

ZN 82052000 PG 1

fein blank, mit gerilltem rundem Spezial-Gummigriff, ohne oder mit Dauermagnet

polished, with steel pipe handle and annulated round rubber grip, also with permanent magnet

poli, avec manche tube d'acier et coup de main en plastique / avec aimant permanent

0021700-10	12	RS	008319	29,30
0021700-12	12	RS	008326	29,30
0021700-14	12	RS	008333	29,30
0021700-16	12	RS	008340	29,30
0021710-10	12	RS mit Magnet	008357	36,60
0021710-12	12	RS mit Magnet	008364	36,60
0021710-14	12	RS mit Magnet	008371	36,60
0021710-16	12	RS mit Magnet	021851	36,60

218



Losschlageisen
Tool for removing nails
Ciseu de garnisseur

ZN 82055980 PG 1

fein blank, Holzheft

polished

poli

0021800	12	155 g	008388	26,85
---------	----	-------	--------	-------

Art. EAN 4016671 EURO

218 1/2



Losschlageisen
Tool for removing nails
Ciseu de garnisseur

ZN 82055980 PG 1

fein blank, mit Klaue, Holzheft

polished, with claw

poli, avec arrache-clou

0021890	12	155 g	008401	29,65
---------	----	-------	--------	-------

219



Nagelheber
Nail puller
Arrache-clou de garnisseurs

ZN 82055980 PG 1

fein blank, Zwinge, Holzheft

polished

poli

0021900	12	105 g	008418	28,75
---------	----	-------	--------	-------

221



Tapezierhammer
Hammer for carpet layers
Marteau de tapiciers

ZN 82052000 PG 1

fein blank, mit gerilltem rundem Stiel mit umliegender Feder

polished, with annulated round handle and salient strap around

poli, avec manche rond rainuré à clavettes

0022101-08	12	ES	008432	40,20
0022101-10	12	ES	008449	40,20

222



Polsterhammer
Hammer for upholsterers
Marteau de tapiciers

ZN 82052000 PG 1

zwei runde Bahnen (Durchm. 10 + 14 mm), mit Dauermagnet, fein blank

with permanent magnet, polished

avec aimant permanent, poli

0022201	12	ES	008456	31,85
---------	----	----	--------	-------

521



Sattlerhammer
Hammer for upholsterers
Marteau de sellier

ZN 82052000 PG 1

Stahlstiel mit aufgenieteten Heften

with iron handle and riveted wooden scales

avec manche d'acier et coup de main en bois

0052100	6	460 g	008487	65,90
---------	---	-------	--------	-------

Art.			EAN 4016671	EURO
522				
				
Anreibhammer Special Hammer Marteau spécial				
ZN 82052000 PG 1 für Bodenleger, Breite der Anreibfinne: 90 mm for floor and carpet layers pour l'ajustement des tapis-plein				
0052201	1	ES 500 g	015461	30,15

Art.			EAN 4016671	EURO
523				
				
Treppeneisen Stair Tool Outil spécial				
ZN 82055980 PG 1 verchromt, Schneide 70 mm chrome-plated chromé				
0052300	12	390 g	008494	19,15

Art.			EAN 4016671	EURO
523a				
				
Treppeneisen Stair Tool Outil spécial				
ZN 82055980 PG 1 verchromt, Schneide 90 mm chrome-plated chromé				
0052310	12	540 g	015478	24,40

8 Nietenzieher und -köpfer, Körner usw.
Rivet Punches, Rivet Sets and Centre Punches
Bouterolles, Chasses Rivets et Pointeaux

Art.			EAN 4016671	EURO
50				
				
Nietenzieher Rivet Punche Chasse rivet				
ZN 82055980 PG 1 achtkantig, Chrom-Vanadium octogon, Chrome Vanadium octogonale, Chrom Vanadium				
0005000-02	1	40 g	003574	3,75
0005000-03	1	70 g	003581	3,75
0005000-04	1	90 g	003598	4,05
0005000-05	1	120 g	003604	5,05
0005000-06	1	170 g	003611	5,60
0005000-08	1	280 g	003628	8,30
0005000-10	1	500 g	003635	10,85

Art.			EAN 4016671	EURO
51				
				
Nietenköpfer Rivet Set Bouterolle				
ZN 82055980 PG 1 achtkantig, Chrom-Vanadium octogon, Chrome Vanadium octogonale, Chrom Vanadium				
0005100-02	1	40 g	003642	3,75
0005100-03	1	70 g	003659	3,75
0005100-04	1	90 g	003666	4,05
0005100-05	1	120 g	003673	5,05
0005100-06	1	170 g	003680	5,60
0005100-08	1	280 g	003697	8,30
0005100-10	1	500 g	003703	10,85

Art.			EAN 4016671	EURO
52				
				
komb. Nietenzieher u. -köpfer Rivet Set and Punch in one piece Bouterolle et Chasse rivet combiné en une pièce				
ZN 82055980 PG 1				
0005200-02	1	150 g	003710	16,15
0005200-03	1	150 g	003727	16,15
0005200-04	1	200 g	003734	16,15
0005200-05	1	200 g	003741	17,10
0005200-06	1	300 g	003758	17,10

Art.			EAN 4016671	EURO
58				
				
Körner Centre Punche Pointeau				
ZN 82055980 PG 1 DIN 7250, achtkantig, Chrom-Vanadium octogon, Chrome Vanadium octogonale, Chrom Vanadium				
0005800-120X10	1	90 g	004014	2,50
0005800-120X12	1	90 g	004021	3,00
0005800-130X16	1	100 g	004038	6,25

Art.			EAN 4016671	EURO
72				
				
Meißelhandschutz Universal chisel hand guard Pare-main universel				
ZN 39269097 PG 1 für alle Meißel passend				
0007200	1		010688	3,95

9 Sonderwerkzeuge
Special Tools
Outils spéciaux

Art. EAN 4016671 EURO

350



Kanaldeckelhammer
Special Hammer for water-works
Marteau pour couvercle de canal

ZN 82052000 PG 1
Spezialgriff
with tubular steel shaft and special grip
avec manche en tube d'acier et poignée en plastique

0035000	12	RS 500 g	008500	64,85
---------	----	----------	--------	-------

361



Geologenhammer
Hammer for geologists
Marteau pour géologues

ZN 82052000 PG 1
Spezialgriff, mit Spitze
with tubular steel shaft and plastic grip, with point
avec manche en tube d'acier, poignée en plastique, avec pointe

0036100-300	12	RS	008517	54,20
0036100-500	12	RS	008524	59,00

361 1/2



Geologenhammer
Hammer for geologists
Marteau pour géologues

ZN 82052000 PG 1
Spezialgriff, mit Schneide
with tubular steel shaft and plastic grip, with edge
avec manche en tube d'acier, poignée en plastique, avec taillant

0036190-300	12	RS	008531	54,20
0036190-500	12	RS	008548	59,00

761 / 761 1/2



Geologenhammer
Hammer for geologists
Marteau pour géologues

ZN 82052000 PG 1
Ledergriff, mit Spitze oder Schneide
leather-handle, with point or edge
manche en cuir, avec pointe ou taillant

0076100-500	12	mit Spitze	024135	72,15
0076190-500	12	mit Schneide	024654	72,15

Art. EAN 4016671 EURO

561 / 561 1/2



Geologenhammer
Hammer for geologists
Marteau pour géologues

ZN 82052000 PG 1
2-Komponenten-Griff rot/schwarz, mit Spitze oder Schneide
2-components grip red/black, with point or edge
2-composants poignée rouge/noir, avec pointe ou taillant

0056100-500	12	mit Spitze	024623	55,50
0056190-500	12	mit Schneide	024630	55,50

69b



Holzspalthammer
Wood Splitting-Hammer
Marteau à fendre le bois

ZN 82052000 PG 1
mit Nase

0006921-3000	1	ES	004687	38,20
0006922-3000	1	HS	004694	45,80

83e



Töpferhammer
Hammer for Potters
Marteau de potiers

ZN 82052000 PG 1

0008351	12	ES 300 g	005028	23,55
---------	----	----------	--------	-------

84



Schusterhammer
Shoemakers' Hammer
Marteau de cordonniers

ZN 82052000 PG 1
deutsche Form, Stahl geschmiedet
German pattern
modèle allemand

0008401	6	ES 300 g	020519	18,40
---------	---	----------	--------	-------

98



Dengelhammer
Scythe Hammer
Marteau à battre les faux

ZN 82052000 PG 1
einfach

0009801	12	ES 500 g	005622	17,25
---------	----	----------	--------	-------

Art.			EAN 4016671	EURO
99				
			Dengelhammer Scythe Hammer Marteau à battre les faux	
			ZN 82052000 PG 1 doppelt	
0009901	12	ES 500 g	005639	17,25

Art.			EAN 4016671	EURO
100				
			Dengelamboss Scythe Anvil Enclumette pour faux	
			ZN 82058000 PG 1 kurz, kantig	
0010000	1	500 g	005646	19,40

Art.			EAN 4016671	EURO
101				
			Dengelamboss Scythe Anvil Enclumette pour faux	
			ZN 82058000 PG 1 kurz, spitz	
0010100	1	500 g	005653	19,40

Art.			EAN 4016671	EURO
104				
			Küfersetzhammer Coopers' Hammer Marteau pour tonneliers	
			ZN 82052000 PG 1	
0010401	6	ES 600 g	005677	29,85

Art.			EAN 4016671	EURO
113				
			Fruchtkistenhammer Hammer for orange cases Marteau pour caisses à oranges	
			ZN 82052000 PG 1	
0011301	12	ES 600 g	005684	40,75

Art.			EAN 4016671	EURO
115 / 115a				
			Roststecher Rust Scratcher Grattoir droit	
			ZN 82055910 PG 1 Klinge 6 cm breit	
0011501-0600	1	ES	005691	21,40
0011501-1000	1	ES	005707	28,90
0011511-0320	1	ES	026474	8,10

Art.			EAN 4016671	EURO
240				
			Montagedorn Drift Pin Poinçon	
			ZN 82055980 PG 1 Spezialstahl gehärtet	
0024000-11	1	5,5 x 11 x 66 x 143	021271	20,95
0024000-13	1	6,5 x 13 x 78 x 169	021288	24,35
0024000-17	1	8,5 x 17 x 102 x 221	021295	31,15
0024000-21	1	10,5 x 21 x 126 x 273	021325	45,40
0024000-23	1	11,5 x 23 x 138 x 299	021332	48,50
0024000-25	1	12,5 x 25 x 150 x 325	021349	49,30

Art.			EAN 4016671	EURO
8900010				
			Klanghammer	
			ZN 82052000 PG 1 für Wagenmeister, mit Schlosserhammerkopf nach DIN 1041, 500 gr., mit Eschenstiel 750 mm	
8900010	1			15,60

10 Schweißer-, Gussputz- u. Kesselsteinhammer Welders' and Boiler Scaling Hammers Marteaux de soudeur, Marteaux à piquer les soudures

Art.			EAN 4016671	EURO
29				
			Kesselsteinhammer Boiler Scaling Hammer Marteau à piquer pour chaudières	
			ZN 82052000 PG 1 DIN 6465	
0002901-400	6	ES	002652	15,00
0002901-500	6	ES	002669	15,60

Art.			EAN 4016671	EURO
213				
			Schweißerhammer Hammer for electric welders Marteau de soudeurs	
			ZN 82052000 PG 1 mit Längsschneide (Pickhammer) with straight edge avec taillant en long	
0021301	12	ES 330 g	008197	13,95

Art.			EAN 4016671	EURO
213a				
			Schweißerhammer Hammer for electric welders Marteau de soudeurs	
			ZN 82052000 PG 1 mit Querschneide (Pickhammer) with cross edge avec taillant en travers	
0021311	12	ES 330 g	008203	18,20

Art.			EAN 4016671	EURO
313				
				
Schweißerhammer Hammer for electric welders Marteau de soudeurs				
ZN 82052000 PG 1 DIN 5133, mit Rohrstiel with steel-pipe handle avec manche en tube d'acier				
0031300	12	RS 450 g	008210	15,65

Art.			EAN 4016671	EURO
613				
				
Gussputzhammer Scaling Hammer Marteau à piquer les chaudières				
ZN 82052000 PG 1				
0061301	12	ES 300 g	008227	14,65

11 Schonhämmer Soft Face Hammers Marteaux à tête douce

Art.			EAN 4016671	EURO
320				
				
Holzhammer Wooden Mallet Maillet de bois				
ZN 82052000 PG 2 DIN 7462, mit aufgespresstem Metallmantel Head white beech wood material with metal coat, oval ash handle. Handle and wedge glued. corps en hêtre blanc				
0032001-1	12	ES 50 x 100	015126	16,55
0032001-2	12	ES 60 x 120	008555	18,85
0032001-3	10	ES 70 x 140	008562	21,80
0032001-4	5	ES 80 x 160	008579	28,30

Art.			EAN 4016671	EURO
330				
				
Kupferhammer Cooper Hammer Marteau en cuivre				
ZN 82052000 PG 1 Fäustelform Sledge Hammer shape forme de masse				
0033001-0250	6	ES	008586	24,00
0033001-0500	6	ES	008593	40,00
0033001-0750	6	ES	008609	49,50
0033001-1000	6	ES	008616	57,00
0033001-1500	6	ES	008623	73,40
0033001-2000	6	ES	008630	95,35
0033010-0250	6	mit Fiberglasstiel	025873	37,80
0033010-0500	6	mit Fiberglasstiel	025880	56,20
0033010-0750	6	mit Fiberglasstiel	025897	67,95
0033010-1000	6	mit Fiberglasstiel	025903	76,55
0033010-1500	6	mit Fiberglasstiel	025910	93,10
0033010-2000	6	mit Fiberglasstiel	025927	120,85

Art.			EAN 4016671	EURO
335				
				
Leichtmetallhammer Aluminium hammer Marteau d'aluminium				
ZN 82052000 PG 1 aus Aluminium				
0033501-0250	6	ES 75 x 40	008647	16,35
0033501-0350	6	ES 105 x 40	008654	19,85
0033501-0500	6	ES 92 x 50	008661	25,20
0033501-0750	6	ES 98 x 60	008678	35,00
0033501-1000	6	ES 128 x 60	008685	42,55
0033501-1500	4	ES 140 x 70	008692	61,65

Art.			EAN 4016671	EURO
340				
				
Rückschlagfreier Schonhammer Non-rebound Hammer Massette sans rebond				
ZN 82052000 PG 1 mit leicht auswechselbaren Nylon-Köpfen, für gezielt genau dosiertes Schlagen with Nylon-faces, loose faces in all sizes avec têtes de Nylon, têtes interchangeables en toutes dimensions				
0034002-25	6	HS 280 g	008708	29,90
0034002-30	6	HS 400 g	008715	32,70
0034002-35	6	HS 550 g	008722	36,60
0034002-40	6	HS 700 g	008739	42,25
0034002-45	2	HS 850 g	008746	47,85
0034002-50	2	HS 1000 g	008753	51,75
0034002-60	2	HS 1650 g	008760	91,50
0034002-70	2	HS 2400 g	008777	101,50

Art. EAN 4016671 EURO

345



Rückschlagfreier Schonhammer
Non-rebound Hammer
Massette sans rebond

ZN 82052000 PG 1

mit leicht auswechselbaren Nylon-Köpfen,
mit Stahlrohrstiel und Gummigriff

with Nylon-faces, loose faces in all sizes

avec têtes de Nylon, têtes interchangeables
en toutes dimensions

0034500-25	6	RS 280 g	008784	39,40
0034500-30	6	RS 400 g	008791	41,65
0034500-35	6	RS 550 g	008807	43,45
0034500-40	6	RS 700 g	008814	49,05
0034500-45	2	RS 850 g	008821	55,65
0034500-50	2	RS 1000 g	008838	61,50
0034500-60	2	RS 1650 g	008845	101,55

346



Ferroplex-Kombihammer
Ferroplex-Hammer
Maillet Ferroplex

ZN 82052000 PG 1

mit Stahlrohrstiel und Gummigriff,
Hammerbahn gehärtet und vergütet, mit
auswechselbarem Nylon-Einsatz

with steel tube handle and rubber grip,
hammer face hardened and tempered,
exchangeable nylon insert

avec manche en acier tubulaire et poignée en
caoutchouc. Table de maillet trempée et
traitée. Embout en nylon interchangeable

0034600-30	6	RS	023121	34,30
0034600-35	6	RS	023138	34,75

345a



Ersatz-Schlagkopf
Loose faces for Non-rebound
Hammers
Têtes pour Massettes sans rebond

ZN 39079900 PG 1

für rückschlagfreie Hämmer No. 340, 345
und Ferroplex-Schonhämmer No. 346

0034510-25	1		021462	3,75
0034510-30	1		015256	4,60
0034510-35	1		015263	5,50
0034510-40	1		015270	6,50
0034510-45	1		015287	7,70
0034510-50	1		015294	8,55
0034510-60	1		015300	13,55
0034510-70	1		015317	20,10

Art. EAN 4016671 EURO

380



Spenglerhammer
Plumbers' Hammer
Marteau pour ferblantiers

ZN 39269097 PG 2

eckige Form, aus Spezialkunststoff, hohe
Spannungsrisssbeständigkeit, nachschleif-
bzw. feilbar, doppelt geschweifeter Eschenstiel

of special plastic material, ideal for treatment
of sensitive materials (sheet-metal, etc.),
square shape

en matière plastique, pour des travaux avec
matériaux sensibles, forme quadrangulaire

0038001-145	6	ES 500 g	015324	24,10
0038001-155	4	ES 600 g	015331	30,35

385



Spenglerhammer
Plumbers' Hammer
Marteau pour ferblantiers

ZN 39269097 PG 2

einseitig keilförmig, aus Spezialkunststoff,
hohe Spannungsrisssbeständigkeit,
nachschleif- bzw. feilbar, doppelt
geschweifeter Eschenstiel

of special plastic material, ideal for treatment
of sensitive materials (sheet-metal, etc.),
wedge shape

en matière plastique, pour des travaux avec
matériaux sensibles, forme coin

0038501-155	6	ES 600 g	015348	34,80
-------------	---	----------	--------	-------

390



Spenglerhammer
Plumbers' Hammer
Marteau pour ferblantiers

ZN 39269097 PG 2

zylindrische Form, aus Spezialkunststoff,
hohe Spannungsrisssbeständigkeit,
nachschleif- bzw. feilbar, doppelt
geschweifeter Eschenstiel

of special plastic material, ideal for treatment
of sensitive materials (sheets-metal, etc.),
cylindric shape

en matière plastique, pour des travaux avec
matériaux sensibles, forme cylindrique

0039001-050	6	ES 250 g	015355	23,55
0039001-060	6	ES 420 g	015362	29,50
0039001-070	4	ES 600 g	015379	32,95
0039001-080	4	ES 800 g	015386	46,15

Art.			EAN 4016671	EURO
395				
				
Spenglerhammer Plumbers' Hammer Marteau pour ferblantiers				
		ZN 39269097	PG 2	
Eiform, aus Spezialkunststoff, hohe Spannungsrisssbeständigkeit, nachschleif- bzw. feilbar, doppelt geschweiffter Eschenstiel of special plastic material, ideal for treatment of sensitive materials (sheets-metal, etc.), egg shape en matière plastique, pour des travaille avec matériaux sensibles, forme d'oeuf				
0039501-060	6	ES 420 g	015393	40,05

Art.			EAN	EURO
396				
				
Deckhammer Topping - Mallet Marteau de ferblantiers				
		ZN 44170000	PG 2	
aus Holz, einseitig keilförmig, 50 x 90 x 175 mm Head white beech wood material with round ash handle. Handle and wedge glued, colourless lacquered anguleu, tête fabriquée de charme, avec manche en frêne				
0039601-180	1	ES	022353	20,95

Art.			EAN	EURO
397				
				
Zimmermannsklüpfel Carpenter's Mallet Maillet de charpentiers				
		ZN 44170000	PG 2	
aus Holz				
0039701-140	1	ES	022360	35,25
0039701-160	1	ES	024210	35,60

Art.			EAN	EURO
251/7				
				
Gummihammer Rubber Mallet Maillet caoutchouc				
		ZN 40169997	PG 1	
1 Bahn flach, 1 Bahn gewölbt, Eschenstiel 1 face flat, 1 face bowed 1 face plate, 1 face bombée				
2510701	1	ES 115 x 65	008852	8,55

Art.			EAN 4016671	EURO
251/7a				
				
Gummihammer Rubber Mallet Maillet caoutchouc				
		ZN 40169997	PG 1	
mit flachen Bahnen, Eschenstiel with flat faces avec faces plates				
2510711-0	1	ES 80 x 40	008869	5,00
2510711-1	1	ES 90 x 55	008876	6,30
2510711-2	1	ES 115 x 65	008883	8,55
2510711-3	1	ES 130 x 75	008890	12,00
2510711-4	1	ES 140 x 90	008906	16,90
2510721-2	1	ES weiß	019933	9,45

Art.			EAN	EURO
252/20				
				
Plastikhammer Plastic Hammer Marteau en matière plastique				
		ZN 82052000	PG 1	
mit leicht auswechselbaren Plastikköpfen (Köpfe = ZN 39079900, Stiele = ZN 44170090) with replaceable plastic faces, loose faces in all sizes avec têtes interchangeables, têtes interchangeables en toutes dimensions				
2522001-22	6	ES 160 g	008913	6,05
2522001-27	6	ES 250 g	008920	7,45
2522001-32	6	ES 360 g	008937	9,75
2522001-35	6	ES 450 g	008944	11,70
2522001-40	6	ES 650 g	008951	13,45
2522001-50	6	ES 980 g	008968	21,60
2522001-60	6	ES 1460 g	008975	32,55
2522020-22	1	Ersatzkopf	008982	0,90
2522020-27	1	Ersatzkopf	008999	1,20
2522020-32	1	Ersatzkopf	009002	1,95
2522020-35	1	Ersatzkopf	009019	2,30
2522020-40	1	Ersatzkopf	009026	3,25
2522020-50	1	Ersatzkopf	009033	5,15
2522020-60	1	Ersatzkopf	009040	6,90
2522040-22	1	Ersatzstiel	010855	2,30
2522040-27	1	Ersatzstiel	010862	2,40
2522040-32	1	Ersatzstiel	021776	2,60
2522040-35	1	Ersatzstiel	010879	2,60
2522040-40	1	Ersatzstiel	010886	2,80
2522040-50	1	Ersatzstiel	019728	3,25
2522040-60	1	Ersatzstiel	021783	4,05

Art. EAN 4016671 EURO

252/20a



Nylonhammer
Nylon Hammer
Marteau en matière Nylon

ZN 82052000 PG 1

mit leicht auswechselbaren Nylonköpfen
(Köpfe = ZN 39079900)

with replaceable nylon faces, loose faces in
all sizes

avec têtes interchangeables en Nylon, têtes
interchangeables en toutes dimensions

2522011-22	6	ES 160 g	009057	7,45
2522011-27	6	ES 250 g	009064	9,55
2522011-32	6	ES 360 g	009071	12,15
2522011-35	6	ES 450 g	009088	15,65
2522011-40	6	ES 650 g	009095	19,35
2522011-50	6	ES 980 g	009101	30,75
2522011-60	6	ES 1460 g	009118	36,75
2522030-22	1	Ersatzkopf	009125	1,55
2522030-27	1	Ersatzkopf	009132	1,95
2522030-32	1	Ersatzkopf	009149	3,00
2522030-35	1	Ersatzkopf	009156	3,75
2522030-40	1	Ersatzkopf	009163	5,15
2522030-50	1	Ersatzkopf	009170	10,90
2522030-60	1	Ersatzkopf	009187	12,80

12 Werkzeuge für Zimmerer und Schreiner Carpenters' and Joiners' Tools Marteaux de plafonneur et de menuisier

85



Schreinerhammer, DIN 5109
Joiners' Hammer
Marteau de menuisiers

ZN 82052000 PG 1

franz. Form, gängiges deutsches Modell

French pattern

forme française

0008501-18	12	ES 140 g	005042	10,20
0008501-20	12	ES 190 g	005059	10,20
0008501-22	12	ES 230 g	005066	11,10
0008501-25	12	ES 320 g	005073	11,70
0008501-28	12	ES 400 g	005080	12,55
0008501-30	12	ES 520 g	005097	15,00

87



Schreinerhammer
Joiners' Hammer
Marteau de menuisiers

ZN 82052000 PG 1

engl. Form

English pattern

modèle anglais

0008701-125	12	ES Gr. 00	005127	11,60
0008701-150	12	ES Gr. 0	005134	12,00
0008701-180	12	ES Gr. 1	005141	12,70
0008701-240	12	ES Gr. 2	005158	14,30
0008701-300	12	ES Gr. 3	005165	15,50
0008701-450	12	ES Gr. 4	005172	18,10

Art. EAN 4016671 EURO

97



Fournierhammer
Hammer for Inlaid Woodwork
Marteau de plaçage

ZN 82052000 PG 1

Breite der Anreibfinne: 90 mm

(Veneer Hammers)

0009701	1	ES 500 g	005608	30,15
---------	---	----------	--------	-------

95aS



Latthammer
Carpenters' Roofing Hammer
Marteau de plafonneurs

ZN 82052000 PG 2

süddeutsche Form, schwarz abgeschliffen,
extra starken Federn, geraute Bahn

black finish, with oval ash handle

noirs, modèle allemand, manche frêne ovale

0009521	12	ES 600 g	005585	30,90
---------	----	----------	--------	-------

95b



Latthammer
Carpenters' Roofing Hammer
Marteau de plafonneurs

ZN 82052000 PG 2

Berliner Form, fein blank, extra starke
Federn, geraute Bahn

bright polished with oval ash handle

poli, avec manche frêne ovale

0009541	6	ES 600 g	013887	34,15
---------	---	----------	--------	-------

13 Spezialwerkzeuge für Dachdecker Special Roofmakers' Tools Outils spéciaux de couvreur

207 R



Schieferhammer
Tilers' Hammer
Marteau de couvreurs

ZN 82052000 PG 2

geschmiedet, mit Ledergriff; Schneide, Kopf
und Spitze besonders gut gehärtet, für
Rechtshänder

forged, with leather grip, edge, head and
point specially well haredened, with nail puller,
for right-handers

taillant, avec coup de main en cuir, tête et
pointe spécialement trempées, avec arrache-
clous; pour droitiers

0020700	12	XL, 700 g	007862	64,65
0020700-500	12	XS, 500 g	022186	64,65
0020700-600	12	XM, 600 g	022179	64,65
0020750	1	verchromt	021936	139,25
0020760	1	vergoldet	021950	224,80
G0020750	1	Geschenkkarton	022698	148,40
G0020760	1	Geschenkkarton	022704	233,95

Art. EAN 4016671 EURO

207 L



**Schieferhammer
Tilers' Hammer
Marteau de couvreurs**

ZN 82052000 PG 2
geschmiedet, mit Ledergriff; Schneide, Kopf und Spitze besonders gut gehärtet, für Linkshänder
forged, with leather grip, edge, head and point specially well haredned, with nail puller, for left-handers
taillant, avec coup de main en cuir, tête et pointe spécialement trempées, avec arrache-clous; pour gauchers

0020710	12	650 g, links	007879	64,65
---------	----	--------------	--------	-------

207a R



**Schieferhammer
Tilers' Hammer
Marteau de couvreurs**

ZN 82052000 PG 2
geschmiedet, mit 3 Löchern und Ledergriff; Schneide, Kopf und Spitze besonders gut gehärtet, für Rechtshänder
forged, with leather grip, edge, head and point specially well haredned, with 3 holes, for right-handers
taillant, avec coup de main en cuir, tête et pointe spécialement trempées, avec 3 trous; pour droitiers

0020720	12	650 g, rechts	007886	64,65
---------	----	---------------	--------	-------

207 1/2 R / L



**Schieferhammer
Tilers' Hammer
Marteau de couvreurs**

ZN 82052000 PG 2
geschmiedet, mit Ledergriff; franz. Form, mit seitlichem Nagelzieher, für Rechts- oder Linkshänder
forged, with leather grip, edge, head and point specially well haredned, French pattern, with nail puller, for right- or left-handers
taillant, avec coup de main en cuir, tête et pointe spécialement trempées, forme française, avec arrache-clous; pour droitiers ou gauchers

0020780	12	650 g, rechts	007893	85,85
0020790	12	650 g, links	007909	85,85

Art. EAN 4016671 EURO

208



**Dachdecker-Nageleisen
Tilers' Nail Puller
Arrache-clou de couvreurs**

ZN 82055980 PG 2
mit Klaue am Griff, besonders für dünnen und empfindlichen Schiefer geeignet, da aus hochflexiblem Spezialstahl gefertigt, durch neue Fertigungsmethoden besonders belastbar, geringer Innenradius ermöglicht auch das Entfernen von Nägeln ohne Kopf
with claw on handle, forged
forgé

0020800-315	1	12", 590 g	007916	36,80
0020800-400	1	15", 620 g	007923	40,25
0020800-470	1	18", 750 g	007930	41,75
0020800-600	1	23", 800 g	007947	53,40

209



**Haubücke
Anvil for Slaters
Enclumette de couvreurs**

ZN 82055980 PG 2
gebogen, schwarz lackiert
black finish, bent
noir, courbée

0020900	1	560 g	007954	12,00
0020950	1	verchromt	021943	38,20

209a



**Haubücke
Anvil for Slaters
Enclumette de couvreurs**

ZN 82055980 PG 2
gerade, schwarz lackiert
black finish, straight
noir, droite

0020910	1	560 g	007961	11,70
---------	---	-------	--------	-------

211 / 211a



**Haubücke
Anvil for Slaters
Enclumette de couvreurs**

ZN 82055980 PG 2
gerade, franz. Form, Wate rechts oder links, blank
French pattern, with bevel, polished, right or left
forme française, poli, à droite ou à gauche

0021100	1	575 g, rechts	007985	23,70
0021110	1	575 g, links	007992	23,70

Art.			EAN 4016671	EURO
70209				
0070209-000		1	021981	180,00

**Schiefer-Reparatur-Set
Tilers' Repair Set**

PG 2

bestehend aus einer Aufnahmevorrichtung für Haubrücken und einem Auffangbehälter aus Metall

Art.			EAN	EURO
210				
0021001	12	ES 360 g	007978	24,35
0021010	12	mit Fiberglasstiel	025835	42,00

**Spitzhammer
Tilers' Hammer
Marteau de couvreurs**

PG 2

für Dachdecker; runder Stiel mit zwei starken, geschmiedeten Federn oder mit Fiberglasstiel with point
avec pointe

Art.			EAN	EURO
226				
0022600	5	470 g, 300 mm	008012	77,65

**Faserzement-Handscher
Shear for Tilers
Ciseau pour couvreurs**

PG 2

zum Bearbeiten von Naturschiefer, Eternit und Faserzementplatten (bis 7 mm); staub- und bruchfreier Schneidvorgang

Art.			EAN	EURO
226 1/2				
0022690	5	600 g, 300 mm	008029	103,10

**Faserzement-Hand- und Lochschere
Shear for Tilers
Ciseau pour couvreurs**

PG 2

zum Bearbeiten von Naturschiefer, Eternit und Faserzementplatten (bis 7 mm); staub- und bruchfreier Schneidvorgang; mit Lochvorrichtung für Materialstärken bis 7 mm

Art.			EAN	EURO
226d - h				
Ersatzteile Spare parts				
			ZN 82032000	PG 2
			für Faserzement-Handscher	
0022640	1	Messer 35 mm	020281	20,30
0022650	1	Matrize	020298	18,15
0022670	1	Feder	020267	5,05
0022680	1	Stift / Locher	020991	20,80

Art.			EAN 4016671	EURO
70220				
0070220-210		1	015966	128,95

**Hebel-Eternit- und Schieferschere
Shingle Cutter
Coupe-bardeau d'asphalte**

ZN 82033000 PG 2

schneidet problemlos und völlig bruchfrei Faserzementplatten, Eternit und Naturschiefer, Schnittlänge ca. 200 mm, mit auswechselbarem Schneidmesser; mit Dachlatteneinhängung

Art.			EAN	EURO
70228				
0070228-225	6	400 g	015973	17,60

**Ziegelkneifzange
Tile-Nibbler
Tenaille pour tuiles**

ZN 82032000 PG 2

hochwertige Ausführung mit Drahtabschneider

**14 Werkzeuge für Klempner, Spengler, Gold- / Silberschmiede und Uhrmacher
Tools for Plumbers, Gold- and Silversmiths and Watchmakers
Outils pour ferblantier, horloger, orfèvre, ciseleur**

Art.			EAN	EURO
127				
0012700-600	1	5 kg	005721	319,50
0012700-700	1	7 kg	005738	482,05
0012700-800	1	9 kg	005745	600,95

**Sperrhaken
Anvil for Tinkers
Bigorne pour ferblantiers**

ZN 82058000 PG 2

mit flachgewölbter Bahn und rundstumpfem Horn

Art.			EAN	EURO
128				
0012800-600	1	4,0 kg	005752	319,50
0012800-700	1	5,5 kg	005769	482,05
0012800-800	1	8,5 kg	005776	600,95

**Sperrhaken
Anvil for Tinkers
Bigorne pour ferblantiers**

ZN 82058000 PG 2

mit flacher Bahn und rundspitzem Horn

Art.			EAN	EURO
128a				
0012810-600	1	4,0 kg	005783	319,50
0012810-700	1	5,5 kg	005790	482,05
0012810-800	1	8,5 kg	005806	600,95

**Sperrhaken
Anvil for Tinkers
Bigorne pour ferblantiers**

ZN 82058000 PG 2

mit flachgewölbter Bahn und rundspitzem Horn

Art.			EAN 4016671	EURO
131				
Trichter-Sperrhaken Anvil for Tinkers Bigorne pour ferblantiers				
ZN 82058000 PG 2 mit rundspitzer Bahn und Trichterhorn				
0013100	1	700 mm, 7 kg	005813	801,70

Art.			EAN 4016671	EURO
134				
Sickenstock Moulding Anvil for Tinkers Bigorne à rainures pour ferblantiers				
ZN 82058000 PG 2 ohne Horn without beck sans bec				
0013400	1	300 mm, 4 kg	005820	288,85

Art.			EAN 4016671	EURO
135				
Sickenstock Moulding Anvil for Tinkers Bigorne à rainures pour ferblantiers				
ZN 82058000 PG 2 mit Horn with beck avec bec				
0013500	1	375 mm, 5 kg	005837	334,10

Art.			EAN 4016671	EURO
136				
Schweifstock Fretting Anvil Pied de Biches pour ferblantiers				
ZN 82058000 PG 2				
0013600	1	325 mm, 6 kg	005844	350,00

Art.			EAN 4016671	EURO
137				
Haken-Rillenfaust Hook-Socket Tasseau à crochet				
ZN 82058000 PG 2 Arbeitsfläche fein poliert, Länge 210 mm, Durchm. 57 mm with groove, working surfaces polished avec rainure, surfaces travaillantes polies				
0013700	1	1000 g	005851	142,45

Art.			EAN 4016671	EURO
137b				
Quetschfalzeisen Squeezing Folding Plier Fer à cingler pour border				
ZN 82055980 PG 2 geschmiedet, Schlitztiefe 140 mm forged of special steel forgé en acier spécial				
0013720	1	850 g	005868	56,35

Art.			EAN 4016671	EURO
139				
Bankamboss Square flat Anvil Tas carré				
ZN 82058000 PG 2 Bahn flach, mit einer runden Ecke und geschweifter Kante flat face, one round corner face plate, un coin arrondi				
0013900-050	1	500 g	005875	26,15
0013900-060	1	750 g	005882	39,90
0013900-080	1	1750 g	005899	61,60
0013900-100	1	3250 g	005905	120,80

Art.			EAN 4016671	EURO
140a				
Stiftamboss Anvil for Tinkers Tas pour ferblantiers				
ZN 82058000 PG 2 Arbeitsfläche matt oder fein poliert, Bahn flach, mit vier scharfen Ecken working face dull, flat face, cornered surface travaillante polie mat, face plate, carrée				
0014010-060	1	matt, 2,0 kg	005912	86,35
0014010-080	1	matt, 4,0 kg	005929	165,10
0014010-100	1	matt, 7,5 kg	005936	296,70
0014110-060	1	fein poliert	005943	96,25
0014110-080	1	fein poliert	005950	183,05
0014110-100	1	fein poliert	005967	342,00

Art.			EAN 4016671	EURO
140b				
Stiftamboss Anvil for Tinkers Tas pour ferblantiers				
ZN 82058000 PG 2 Arbeitsfläche matt oder fein poliert, Bahn flach, mit einer runden Ecke und geschweifter Kante working face dull, flat face, one round corner surface travaillante polie mat, face plate, à un coin arrondi				
0014020-060	1	matt, 2,0 kg	005974	86,35
0014020-080	1	matt, 4,0 kg	005981	165,10
0014020-100	1	matt, 7,5 kg	005998	296,70
0014120-060	1	fein poliert	006001	96,25
0014120-080	1	fein poliert	006018	183,05
0014120-100	1	fein poliert	006025	342,00

Art. EAN 4016671 EURO

140c



Stiftamboss
Anvil for Tinkers
Tas pour ferblantiers

ZN 82058000 PG 2
Arbeitsfläche matt oder fein poliert, Bahn leicht gewölbt, vier runde Ecken
working face dull, ball face, 4 round corners
surface travaillante polie mat, face bombée, les quatre coins arrondis

0014030-060	1	matt, 2,0 kg	006032	86,35
0014030-080	1	matt, 4,0 kg	006049	165,10
0014030-100	1	matt, 7,5 kg	006056	296,70
0014130-060	1	fein poliert	006063	96,25
0014130-080	1	fein poliert	006070	183,05
0014130-100	1	fein poliert	006087	342,00

140d



Stiftamboss
Anvil for Tinkers
Tas pour ferblantiers

ZN 82058000 PG 2
Arbeitsfläche matt oder fein poliert, Bahn flach, mit zwei scharfen und zwei runden Ecken und geschweifter Kante
working face dull, flat face, 2 round and 2 sharp corners
surface travaillante polie mat, face plate, à 2 coins arrondis et 2 coins vifs

0014040-060	1	matt, 2,0 kg	006094	86,35
0014040-080	1	matt, 4,0 kg	006100	165,10
0014040-100	1	matt, 7,5 kg	006117	296,70
0014140-060	1	fein poliert	006124	96,25
0014140-080	1	fein poliert	006131	183,05
0014140-100	1	fein poliert	006148	342,00

142



Bördeleisen
Barding socket
Tasseau à border

ZN 82058000 PG 2
hammerschlag-grau lackiert

0014200-30	1	750 g	006155	42,00
0014200-40	1	1200 g	006162	49,30
0014200-50	1	1500 g	006179	57,90

Art. EAN 4016671 EURO

143a / 143b



Umschlageisen
Hatchet Stake
Tranche

ZN 82058000 PG 2
hammerschlag-grau lackiert, Bahn gerade, mit Wate auf einer Seite oder auf die Mitte geschliffen
straight face, with one bevel or face grinded to the middle
face droite ou face meulée au centre

0014310-060	1	Wate einseitig	006186	45,70
0014310-080	1	Wate einseitig	006193	50,55
0014310-100	1	Wate einseitig	006209	64,40
0014320-060	1	Bahn auf Mitte	006216	45,70
0014320-080	1	Bahn auf Mitte	006223	50,55
0014320-100	1	Bahn auf Mitte	006230	64,40

144



Umschlageisen
Hatchet Stake
Tranche

ZN 82058000 PG 2
hammerschlag-grau lackiert, Bahn ovalrund, mit Wate auf einer Seite
oval face
face ovale

0014400-080	1	1000 g	006247	53,10
0014400-100	1	1400 g	006254	67,50

145



Umschlageisen
Hatchet Stake
Tranche

ZN 82058000 PG 2
hammerschlag-grau lackiert, gerade Bahn, auf einer Seite abgerundet, Wate auf einer Seite
straight face, one side rounded off
face droite, d'un côté arrondi

0014500-080	1	1000 g	006261	53,10
0014500-100	1	1400 g	006278	67,50

146



Umschlageisen
Hatchet Stake
Tranche

ZN 82058000 PG 2
hammerschlag-grau lackiert, Bahn hochrund, mit Wate auf einer Seite
ball face
face bombée

0014600-080	1	1000 g	006285	53,10
0014600-100	1	1400 g	006292	67,50

Art.			EAN 4016671	EURO
147				
Faust Socket Tasseau ZN 82058000 PG 2 hammerschlag-grau lackiert, Arbeitsfläche fein poliert, runde Bahn, flach working face fine polished, round, face flat surface travaillante polie fin, rond, face plate				
0014700-30	1	800 g	006308	56,85
0014700-40	1	1000 g	006315	56,85
0014700-50	1	1600 g	006322	77,80

Art.			EAN 4016671	EURO
150				
Faust Socket Tasseau ZN 82058000 PG 2 hammerschlag-grau lackiert, Arbeitsfläche fein poliert, Bahn rund, hochrund-gewölbt working face fine polished, face high bowed surface travaillante polie fin, face bombée				
0015000-30	1	800 g	006452	56,85
0015000-40	1	1000 g	006469	56,85
0015000-50	1	1600 g	006476	77,80

Art.			EAN 4016671	EURO
148				
Faust Socket Tasseau ZN 82058000 PG 2 hammerschlag-grau lackiert, Arbeitsfläche fein poliert, Bahn vierkant, flach, zwei Ecken abgerundet (Tassoform) working face fine polished, flat face, 2 corners rounded off surface travaillante polie fin, face plate, 2 coins arrondis				
0014800-40	1	1000 g	006346	56,85
0014800-50	1	1600 g	006353	77,80

Art.			EAN 4016671	EURO
151				
Faust Socket Tasseau ZN 82058000 PG 2 hammerschlag-grau lackiert, Arbeitsfläche fein poliert, Bahn flach, eiförmig working face fine polished, working face flat surface travaillante polie fin, face plate				
0015100-40	1	1000 g	006490	62,40

Art.			EAN 4016671	EURO
149				
Faust Socket Tasseau ZN 82058000 PG 2 hammerschlag-grau lackiert, Arbeitsfläche fein poliert, Bahn rund, flach-gewölbt working face fine polished, round face, slightly belled surface travaillante polie fin, face ronde, un peu bombée				
0014900-30	1	800 g	006377	56,85
0014900-40	1	1000 g	006384	56,85
0014900-50	1	1600 g	006391	77,80

Art.			EAN 4016671	EURO
153				
Faust Socket Tasseau ZN 82058000 PG 2 hammerschlag-grau lackiert, Arbeitsfläche fein poliert, gebogen, Bahn rund, hochrund- gewölbt working face fine polished, face high bowed surface travaillante polie fin, face bombée				
0015300-40	1	1500 g	006544	136,70
0015300-50	1	2250 g	006551	159,10

Art.			EAN 4016671	EURO
149 1/2				
Faust Socket Tasseau ZN 82058000 PG 2 hammerschlag-grau lackiert, Arbeitsfläche fein poliert, Bahn rund, auf Mitte gewölbt working face fine polished, round face, bowed to the middle surface travaillante polie fin, face ronde, bombée au milieu				
0014990-30	1	800 g	006414	56,85
0014990-40	1	1000 g	006421	56,85
0014990-50	1	1600 g	006438	77,80

Art.			EAN 4016671	EURO
156a				
Einsteckamboss Anvil for Bearing Irons Tas pour chevalets ZN 82058000 PG 2 für Lagereisen, Bahn 50 x 80 mm				
0015610-2	1		006568	219,50

Art.			EAN 4016671	EURO
156b				
Einsteckamboss Anvil for Bearing Irons Tas pour chevalets ZN 82058000 PG 2 für Lagereisen, Bahndurchm. 65 mm				
0015620-2	1		006575	219,50

Art.			EAN 4016671	EURO
156c				
			Einsteckamboss Anvil for Bearing Irons Tas pour chevalets	
			ZN 82058000 PG 2	
			für Lagereisen, Bahndurchm. 65 mm	
0015630-2	1		006582	219,50

Art.			EAN 4016671	EURO
156d				
			Einsteckamboss Anvil for Bearing Irons Tas pour chevalets	
			ZN 82058000 PG 2	
			für Lagereisen, Bahn 60 x 60 mm	
0015640-2	1		006599	219,50

Art.			EAN 4016671	EURO
156e				
			Einsteckamboss Anvil for Bearing Irons Tas pour chevalets	
			ZN 82058000 PG 2	
			für Lagereisen, Bahn 60 x 60 mm	
0015650-2	1		006605	219,50

Art.			EAN 4016671	EURO
158				
			Bodenamboss Bottom socket Rebatoioir	
			ZN 82058000 PG 2	
			Arbeitsfläche flach, Rand verschieden stark, Durchm. 100 mm, Länge 300 mm	
			with round flat face	
			avec face rond, plate	
0015800	1	7,0 kg	006643	569,65

Art.			EAN 4016671	EURO
159				
			Bodenamboss Bottom socket Rebatoioir	
			ZN 82058000 PG 2	
			Arbeitsfläche gewölbt, gleichmäßig starker Rand, Durchm. 100 mm, Länge 210 mm	
			bowed face	
			face bombée	
0015900	1	7,0 kg	006650	534,90

Art.			EAN 4016671	EURO
160				
			Knopfamboss Brasiers' Anvil Tas pour chaudronniers	
			ZN 82058000 PG 2	
			Arbeitsfläche gewölbt, Durchm. 100 mm, Länge 180 mm	
			bowed face	
			face bombée	
0016000	1	4,0 kg	006667	534,90

Art.			EAN 4016671	EURO
164				
			Tasso Socket Tasseau	
			ZN 82058000 PG 2	
			mit rechteckiger Bahn, poliert, mit Schweifkante gegenüber der runden Seite	
			rectangular face, polished	
			face rectangulaire, polie	
0016400-75X80	1	4,0 kg	006728	255,95
0016400-80X90	1	5,0 kg	006735	288,65

Art.			EAN 4016671	EURO
164a				
			Tasso Socket Tasseau	
			ZN 82058000 PG 2	
			mit quadratischer Bahn, poliert, mit Schweifkante neben der runden Seite	
			square face, polished	
			face carrée, polie	
0016410-80X80	1	4,0 kg	006742	255,95
0016410-90X90	1	5,0 kg	006759	288,65

Art.			EAN 4016671	EURO
152				
			Untersatz Stand Socle s'employer	
			ZN 82058000 PG 2	
			mit zwei Einstecklöchern in verschiedenen Größen, passend für Fäuste und Umschlageisen bis 80 mm, Bördeleisen und Stiftambosse bis 60 mm	
			suitable for Sockets, Hatches Stakes, Bording Sockets up to 80 mm, Anvils for Tinkers 60 mm	
			pour Tasseaux, Tranches, Tasseaux à border à 80 mm, Tas pour ferblantiers de 60 mm	
0015200	1	6000 g	006513	90,45

Art.			EAN 4016671	EURO
152a				
	Arbeitsständer Working Block Bloc de Travail			
			ZN 82058000	PG 2
			mit verschiedenen tiefen Mulden zum Aufziehen und Treiben, Höhe 590 mm, Durchm. 420 mm	
0015210	1	50 kg	006520	1.099,90

Art.			EAN 4016671	EURO
152b				
	Rohrstangenhalter Working Stand Outillage pour chevales			
			ZN 82055980	PG 2
			mit Ablageblech, Höhe 1070 mm	
0015220	1	67 kg	006537	2.112,30

Art.			EAN 4016671	EURO
157				
	Rohrstange Pipe Anvil Barre de Toliers			
			ZN 82058000	PG 2
			Arbeitsfläche gewölbt, sauber gehobelt, Stirnseiten abgeschrägt, Enden ca. 500 mm gehärtet. Andere Abmessungen und Längen auf Anfrage	
			working face polished, hardened at ends approx. 500 mm	
			surface travaillante polie, trempé aux bouts 500 mm environ	
0015700-150X5	1	27,5 kg	006612	471,50
0015700-200X5	1	38,0 kg	006629	640,65

Art.			EAN 4016671	EURO
157a				
	Rinnenfaust Socket Tasseau			
			ZN 82058000	PG 2
			Arbeitsfläche blank, eine Stirnseite abgeschrägt	
			working surface polished	
			surface travaillante polie	
0015710	1	125 x 50	006636	57,10
0015730	1	umgekehrt geschrägt	013917	57,10

Art.			EAN 4016671	EURO
161				
	Doppelfalzeisen Double Welt Iron Fer double-pli			
			ZN 82058000	PG 2
			140 mm, aus Stahl geschmiedet, Prismahöhe 25 und 35 mm	
			steel forged, height of prisme 25 and 35 mm	
			forgés en acier, hauteur du prisme 25 et 35 mm	
0016100	1	3,4 kg	006674	121,45

Art.			EAN 4016671	EURO
163				
	Schaleisen Flat Scraper Racloir			
			ZN 82058000	PG 2
			140 mm, geschmiedet, mit langem Blatt, Prisma 25 mm mit Bohrung: 5 mm, 15 mm tief	
			steel forged, prisme 25 mm with bore hole 5/15 mm	
			forgé en acier, prisme 25 mm avec perçage de 5/15 mm	
0016300	1	2,5 kg	006681	111,45

Art.			EAN 4016671	EURO
163 1/2				
	Schaleisen Flat Scraper Racloir			
			ZN 82058000	PG 2
			100 mm, geschmiedet, mit langem Blatt, Prisma 20 mm mit Bohrung: 5 mm, 15 mm tief	
			steel forged, prisme 20 mm with bore hole 5/15 mm	
			forgé en acier, prisme 20 mm avec perçage de 5/15 mm	
0016390	1	1,4 kg	006698	111,45

Art.			EAN 4016671	EURO
163a				
	Eckschaleisen Angle Flat Scraper Racloir d'angle			
			ZN 82058000	PG 2
			Arbeitsflächen blank, große Arbeitsfläche fein poliert	
			bright working faces	
			faces travaillantes polies	
0016310	1	1500 g	006704	180,05

Art.			EAN 4016671	EURO
163b				
	Falzhammer Hammer for Angle Flat Scraper Marteau pour racloir d'angle			
			ZN 82052000	PG 2
			zum Eckschaleisen, Arbeitsflächen fein poliert	
0016321	6	ES 300 g	006711	21,20

Art.			EAN 4016671	EURO
------	--	--	----------------	------

165



Schlichthammer
Double headed Plumbers' Hammer
Marteau Postillon

ZN 82052000 PG 2
eine runde u. eine vierkt. Bahn, beide Bahnen flach, fein poliert

0016501-0200	6	ES	006773	26,10
0016501-0300	6	ES	006780	26,10
0016501-0375	6	ES	006797	26,10
0016501-0500	6	ES	006803	26,10

166



Schlichthammer
Planishing Hammer
Marteau Postillon

ZN 82052000 PG 2
zwei vierkt. Bahnen, eine flach, die andere leicht gewölbt, fein poliert

0016601-0375	6	ES	006810	26,10
--------------	---	----	--------	-------

167



Ausschlichthammer
Planishing Hammer
Marteau Postillon

ZN 82052000 PG 2
zwei runde Bahnen, eine flach, die andere leicht gewölbt, fein poliert

0016701-0200	6	ES	006827	26,10
0016701-0375	6	ES	006834	26,10
0016701-0500	6	ES	006841	26,10

168



Ausschlichthammer
Planishing Hammer
Marteau Postillon

ZN 82052000 PG 2
runde Bahn leicht gewölbt, vierkt. Bahn flach, fein poliert

0016801-0300	6	ES	006858	26,10
0016801-0375	6	ES	006865	26,10
0016801-0500	6	ES	006872	26,10

169



Dopp. Spann.- u. Polierhammer
Polishing Hammer
Marteau à polir

ZN 82052000 PG 2
zwei runde Bahnen, eine flach-gewölbt, die andere hochrund, fein poliert

0016901-0250	6	ES	006889	26,10
0016901-0375	6	ES	006896	26,10
0016901-0500	6	ES	006902	26,10
0016901-0750	1	ES	006919	41,35
0016901-1000	1	ES	006926	59,05

Art.			EAN 4016671	EURO
------	--	--	----------------	------

170



Polierhammer
Polishing Hammer
Marteau à polir

ZN 82052000 PG 2
zwei runde Bahnen, verschieden hoch gewölbt, fein poliert

0017001-0250	6	ES	006933	26,10
0017001-0375	6	ES	006940	26,10
0017001-0500	6	ES	006957	26,10
0017001-0750	1	ES	006964	41,35
0017001-1000	1	ES	006971	59,05

171



Spannhammer
Stretching Hammer
Marteau à étirer

ZN 82052000 PG 2
zwei runde Bahnen, eine flach, die andere leicht gewölbt, fein poliert

0017101-0250	6	ES	006988	26,10
0017101-0375	6	ES	006995	26,10
0017101-0500	6	ES	007008	26,10

173



Tellerhammer
Chasing Hammer
Marteau à bouge

ZN 82052000 PG 2
Bahnen verschieden stark und verschieden gewölbt, fein poliert

0017301-0250	6	ES	007015	26,10
0017301-0375	6	ES	007022	26,10

174



Treibhammer
Embossing Hammer
Marteau à emboutir

ZN 82052000 PG 2
Bahnen verschieden stark hochrund gewölbt, fein poliert

0017401-0175	6	ES	007039	26,10
0017401-0250	6	ES	007046	26,10
0017401-0375	6	ES	007053	26,10
0017401-0500	6	ES	007060	26,10
0017401-0750	1	ES	007077	41,35
0017401-1000	1	ES	007084	59,05

175



Schweifhammer
Grooving Hammer
Marteau à gorge

ZN 82052000 PG 2
Bahnen verschieden stark und verschieden gewölbt, fein poliert

0017501-0250	6	ES	007091	26,10
0017501-0375	6	ES	007107	26,10
0017501-0500	6	ES	007114	26,10

Art.			EAN 4016671	EURO
175 1/2				
			Kreuzschweifhammer Special Grooving Hammer Marteau spécial à gorge	
			ZN 82052000 PG 2	
			Bahnen verschieden stark und verschieden gewölbt, fein poliert	
0017591-0250	6	ES	007121	38,80
0017591-0375	6	ES	007138	38,80

177				
			Sickenhammer Bording Hammer Marteau à suage	
			ZN 82052000 PG 2	
			verschieden stark, fein poliert	
0017701-0200	6	ES	007145	26,10
0017701-0300	6	ES	007152	26,10
0017701-0500	6	ES	007169	26,10

180 / 182				
			Einbahniger Spannhammer Stretching Hammer Marteau à étirer	
			ZN 82052000 PG 2	
			runde Bahn, fein poliert, flach oder leicht gewölbt	
0018001-0375	6	flach	007176	26,10
0018201-0375	6	leicht gewölbt	007183	26,10

182a				
			Einbahniger Polierhammer Polishing Hammer Marteau à polir	
			ZN 82052000 PG 2	
			runde Bahn, hochrund gewölbt, fein poliert	
0018211-0375	6	ES	007190	26,10
0018211-1000	1	ES	007206	59,05

184				
			Silberschmiede-Pinnhammer Planishing and Grooving Hammer Marteau à planer et suager	
			ZN 82052000 PG 2	
			runde Bahn leicht gewölbt, fein poliert	
0018401-0375	6	ES	007213	26,10

186				
			Silberschmiede-Schlichhammer Planishing Hammer for Silversmiths Marteau à planer pour orfèvres	
			ZN 82052000 PG 2	
			zwei runde Bahnen, eine flach, die andere leicht gewölbt, fein poliert	
0018601-0170	6	ES	007220	26,10

Art.			EAN 4016671	EURO
187				
			Silberschmiede-Tellerhammer Chasing Hammer for Silversmiths Marteau à planer pour orfèvres	
			ZN 82052000 PG 2	
			zwei verschieden gewölbte Bahnen, fein poliert	
0018701-0375	6	ES	007237	26,10

189				
			Pritschhammer Large Face Boiler-Makers' Hammer Marteau pour chaudronniers	
			ZN 82052000 PG 2	
			Bahn 100 x 30 à grande panne	
0018901-900	6	ES 100 x 30	007244	55,40

203 1/2				
			Goldschmiedehammer Goldsmiths' Hammer Marteau pour orfèvres	
			ZN 82052000 PG 2	
			verchromt chrome-plated chromé	
0020391	12	ES 80 g	007749	27,90

204				
			Uhrmacherhammer Watchmakers' Hammer Marteau d'horlogers	
			ZN 82052000 PG 2	
			verchromt chrome-plated chromé	
0020401	12	ES 50 g	007756	21,10

205				
			Ciselierhammer Chasing Hammer Marteau de ciseleurs	
			ZN 82052000 PG 2	
			ganz blank, flache Bahn, Revolverstiel polished, with revolver type handle, flat face poli, avec manche forme revolver, face droite	
0020501-22	1	ES	007763	38,80
0020501-26	1	ES	007770	38,80
0020501-28	1	ES	007787	38,80
0020501-30	1	ES	007794	42,70
0020501-32	1	ES	007800	42,70

Art.			EAN 4016671	EURO
165a				
				
Punzensatz Set for chased work Jeu à ciseler ZN 82058000 PG 2 10-teilig, mit verschiedenen Ornamenten, Länge 100 mm with different ornaments, containing 10 pieces avec d'ornaments differents de 10 pièces				
0016510	1	300 g	006766	104,10

Art.			EAN 4016671	EURO
201				
				
Silberschmiede-Sperrhaken Anvil for Silversmiths Enclumette pour orfèvres ZN 82058000 PG 2 fein poliert				
0020100	1	500 g, 135 mm	019773	148,10

Art.			EAN 4016671	EURO
201 1/2				
				
Uhrmacher-Ambösschen Watchmakers' Anvil Tas d'horloger ZN 82058000 PG 2 mit zwei Hörnern, Arbeitsfläche fein poliert polished poli				
0020190	1	400 g, 120 mm	007725	64,75

Art.			EAN 4016671	EURO
202				
				
Uhrmacher-Ambösschen Watchmakers' Anvil Tas d'horloger ZN 82058000 PG 2 mit zwei Hörnern, verchromt chrome-plated chromé				
0020200	1	400 g, 120 mm	007732	93,10

Art.			EAN 4016671	EURO
190				
				
Falzmeißel Bottom Swage Sous-étampe ZN 82055980 PG 2 with tail				
0019000-04	1	200 g	007268	21,20
0019000-06	1	200 g	007282	21,20
0019000-07	1	250 g	007299	23,40
0019000-08	1	250 g	007305	23,40
0019000-10	1	250 g	007329	25,10
0019000-12	1	250 g	007343	25,10

Art.			EAN 4016671	EURO
191				
				
Kerbmeißel Necking tool Ciseau ZN 82055980 PG 2				
0019100	1	100 mm / 1100g	014907	29,20

Art.			EAN 4016671	EURO
192				
				
Klempner-Flachzange Flat Plier for Plumbers Pince plate pour ferblantiers ZN 82032000 PG 2 mit blankem Maul with polished jaws				
0019200-260	1	450 g	007367	39,35

Art.			EAN 4016671	EURO
193				
				
Klempner-Rundzange Round Nose Plier for Plumbers Pince ronde pour ferblantiers ZN 82032000 PG 2 mit blankem Maul Forged quality steel, PVC coated Handles, round - profile jaws en acier forgé, branches revêtues de PVC, mâchoiers rondes				
0019300-260	1	400 g	007374	43,75

Art.			EAN 4016671	EURO
194b				
				
Deckzange Folding Plier for Plumbers Pince à tirer ZN 82032000 PG 2 gerade, mit durchgestecktem Gewerbe straight droite				
0019420-100	1	1800 g, 450 mm	007381	132,85
0019420-120	1	1950 g, 465 mm	007398	152,20
0019420-140	1	2300 g, 500 mm	007404	164,05
0019420-160	1	2500 g, 525 mm	007411	178,80
0019420-180	1	3000 g, 550 mm	007428	209,05
0019420-200	1	3100 g, 575 mm	007435	218,35

Art.			EAN 4016671	EURO
194 1/2				
Deckzange Folding Plier for Plumbers Pince à tirer ZN 82032000 PG 2 gekröpft, mit durchgestecktem Gewerbe cranked courbée				
0019490-100	1	1800 g, 450 mm	007442	157,90
0019490-120	1	1950 g, 465 mm	007459	182,40
0019490-140	1	2350 g, 500 mm	007466	198,55
0019490-160	1	2650 g, 525 mm	007473	214,60
0019490-180	1	3100 g, 550 mm	007480	250,20
0019490-200	1	3200 g, 575 mm	007497	261,90
194c				
Falzzange Folding Plier for Plumbers Pince à tirer ZN 82032000 PG 2 gerade straight droite				
0019430-22	1	230 g, 180 mm	014921	43,10
0019430-40	1	530 g, 240 mm	007503	51,80
0019430-60	1	840 g, 260 mm	007510	50,30
0019430-80	1	1000 g, 300 mm	007527	71,85
194d				
Falzzange Folding Plier for Plumbers Pince à tirer ZN 82032000 PG 2 45° gekröpft cranked courbée				
0019440-22	1	230 g, 180 mm	014938	45,70
0019440-40	1	550 g, 240 mm	007534	57,50
0019440-60	1	850 g, 260 mm	007541	55,25
0019440-80	1	1000 g, 300 mm	007558	79,10
194e				
Falzzange Folding Plier for Plumbers Pince à tirer ZN 82032000 PG 2 90° gekröpft cranked courbée				
0019450-40	1	550 g, 240 mm	007565	76,95
0019450-60	1	850 g, 260 mm	007572	60,95
0019450-80	1	1000 g, 300 mm	007589	115,05

Art.			EAN 4016671	EURO
70910				
Quetschfalzzange Seaming plier for high seams Pince à dresser ZN 82032000 PG 2 droite, PVC, entre-passée				
0070910-080	1	325 mm	016574	136,95
70920				
Eckfalzzange Corner seaming and clinching plier Pince à border pour coins ZN 82032000 PG 2				
0070920-060	1		016581	78,60
70930				
Falzaufbiegezange Seam opening plier Pince à ouvrir les plis, PVC, encastrée ZN 82032000 PG 2 zum schnellen Öffnen von Steh- und Doppelfälzen forged, for the fast opening of standing seams and double seams forgée, pour l'ouverture rapide des assemblages par agrafage et des plis doubles				
0070930-250	1		016598	68,40
194				
Dreikant-Vollschaber Triangle scraper Grattoir triangulaire massifs ZN 82055910 PG 2 Chrom-Vanadium, andere Größen lieferbar				
0019400-150	1	105 g	007596	6,15
0019400-200	1	140 g	007602	7,75
0019400-250	1	195 g	007619	8,25
195				
Dreikant-Hohlschaber Triangle hollow scraper Grattoir triangulaire évidés ZN 82055910 PG 2 Chrom-Vanadium				
0019500-150	1	90 g	007626	7,70
0019500-200	1	135 g	007633	9,40
0019500-250	1	200 g	007640	10,20

Art.			EAN 4016671	EURO
196				
Dreikant-Löffelschaber Triangle spoon scraper Grattoir creux triangulaire				
			ZN 82055910	PG 2
Chrom-Vanadium, andere Größen lieferbar				
0019600-150	1	95 g	007657	6,85
0019600-200	1	140 g	007664	8,40
0019600-250	1	200 g	007671	10,15

197				
Lagerschaber American spoon scraper Grattoir creux tranchant				
			ZN 82055910	PG 2
Chrom-Vanadium, andere Größen lieferbar				
0019700-150	1	95 g	007688	7,10
0019700-200	1	135 g	007695	9,00

198				
Flachschaber Flat scraper Grattoir plat				
			ZN 82055910	PG 2
Chrom-Vanadium, andere Größen lieferbar				
0019800-150	1	150 g	007701	7,80
0019800-200	1	190 g	007718	9,40

70840				
Rinneisenabbiegezange Gutter-outlet forming plier Pince pour crochets de gouttière				
			ZN 82032000	PG 2
mit Einstellschraube und Abgleitrolle, Schlitzbreite 10 mm, für Rinneisen bis 40 x 6 cm				
0070840-620	1		011708	103,80
0070840-800	1		011715	106,95

70850				
Rinnen-Richtheber Gutter-adjusting plier Pince pour ajuster les gouttières				
			ZN 82032000	PG 2
für alle Größen				
0070850-650	1		016536	78,05

70860				
Winkelfalzschließer Single lock hand seamer Pince à joints debout simple				
			ZN 82055980	PG 2
zum Schließen des Winkelfalzes, gleichermaßen geeignet für winkelige Fassaden und längere Scharen, kann senkrecht, waagrecht und schräg eingesetzt werden, Arbeitsbreite 220 mm				
0070860-000	1		016543	264,05

Art.			EAN 4016671	EURO
70865				
Traufenschließer Drip edge seamer Pieuse à larmiers coudée				
			ZN 82055980	PG 2
zum Schließen der vorgefalteten Traufenkante, Fertigfalzen ohne Hammer, Fertigbiegen der Traufenkante in zwei Arbeitsgängen, Arbeitsbreite 220 mm				
0070865-000	1		016550	264,05

70870				
Traufenkanter Drip edge bender Pieuse à larmiers droits				
			ZN 82055980	PG 2
zum schnellen und sauberen Einfalzen des Bleches an der Traufe, Dachgauben und Abtreppungen; ermöglicht Kantungen von über 90°; umgelegter Doppelstehfalz kann durch die breite Öffnung mit abgekantet werden, Einfalzen ohne Hammer, Arbeitsbreite 250 mm				
0070870-000	1		016567	264,05

70875				
Winkeldoppelfalzer Double Seamer				
			ZN 82055980	PG 2
ideal zum Schließen des Winkelfalzes (Fahnenfalz) zum doppelten Stehfalz in einem Arbeitsgang, Arbeitsbreite: 220 mm				
ideal for shaping of locked angleseam to double-seam in one go				
0070875-000	1		025194	342,00

75090				
Weichmetallfeile Tin file Lime pour étain				
			ZN 82031000	PG 2
flachstumpf, mit Kunststoffheft				
0075090-250	10		021073	15,50

15 Messer und Klinsen Knives and Blades Couteaux et Lames

70111				
Universalmesser Universal knife Couteau universel				
			ZN 82119200	PG 2
mit feststehender Klinge				
0070111-005	10		015843	5,20

Art.			EAN 4016671	EURO
70113				
			Automatikmesser Universal knife with retractable blade Couteau avec lame rétractable	
			ZN 82119200 PG 2	
			mit Metallschieber, spezielle Profilaufnahme garantiert festen Sitz der Klinge	
0070113-005		10	015867	5,45

Art.			EAN 4016671	EURO
70120				
			Messer "Delphin" im Köcher	
			ZN 82111000 PG 2	
0070120-000		1	025163	27,35

Art.			EAN 4016671	EURO
70125				
			Klingen-Klappmesser Folding locking utility knife Couteaux pliants	
			ZN 82119300 PG 2	
			Komfort Kunststoffgriff, Klingenfach für Ersatzklingen, Daumenkissen für max. Anpressdruck, Gürtelclip, SB-verpackt, 12 Stck. im Display	
			comfort-grip plastic handle, blade storage with spring release, thumb cushion for max. contact pressure	
			poignée confort plastique, compartiment lames de rechange avec par ressort, support de pouce pour pression à la coupe	
0070125-000		12	025170	20,55
0070161-065		10	Trapezklingen	025637 0,28
0070171-065		10	Hakenklingen	025583 0,75

Art.			EAN 4016671	EURO
70124				
			Messer-Set Knife-set Pochette composition	
			ZN 82119300 PG 2	
			Klingen-Klappmesser in praktischer Tasche aus Nylon + 10 Stück Trapezklingen + 2 Stück Ausstechklingen + 2 Stück Linoleumklingen + 5 Stück Hakenklingen	
0070124-000		1	025736	34,50

Art.			EAN 4016671	EURO
70115				
			Automatikmesser, selbstladend Professional Utility Knife	
			ZN 82119200 PG 2	
			Profi-Cuttermesser mit 5 integrierten Klingen, Zink-Druckguss, schwere Ausführung	
			5 integrated self loading blades, Zinc diecast housing, heavy duty	
0070115-000		12	025590	13,45
0070182-000		1	10 x Klingen	025620 2,25

Art.			EAN 4016671	EURO
70130				
			Abbrechklingenmesser Retractable racor blade knife Couteau à lame rétractable	
			ZN 82119200 PG 2	
			extrem stabile Ausführung für professionellen Einsatz (inkl. 3 Klingen)	
0070130-003		20	015874	7,90

Art.			EAN 4016671	EURO
70190				
			Uni-Messer "Allegro" Trimming Knife "Allegro" Couteau "Allegro"	
			ZN 82119200 PG 2	
			inkl. 5 Klingen mit Köcher, sekundenschneller, werkzeugloser Klingenwechsel durch patentierten Schiebe-Klapp-Riegel	
0070190-005		1	015959	37,40

Art.			EAN 4016671	EURO
70160				
			Trapezklinge Straight blade, 0,63 mm Lame droite, 0,63 mm	
			ZN 82119400 PG 2	
			hochwertige, eisgehärtete Klinge aus Solingen 0,63 mm (zu 10 Stück im Dispenser)	
			high quality, ice-hardened blade from Solingen (10 pcs. in dispenser)	
0070160-065		100	015904	0,27

Art.			EAN 4016671	EURO
70165				
			Doppelschliffklinge Combination blade straight and hooks Lame combination droite et crochet	
			ZN 82119400 PG 2	
			hochwertige, eisgehärtete Klinge aus Solingen 0,63 mm (zu 10 Stück im Dispenser), Haken- und Trapezklinge kombiniert	
0070165-065		100	015911	1,10

Art.			EAN 4016671	EURO
70170				
			Hakenklinge Hooked blade, 0,63 mm Lame à crochets, 0,63 mm	
			ZN 82119400 PG 2	
			hochwertige, eisgehärtete Klinge aus Solingen 0,63 mm (zu 10 Stück im Dispenser)	
0070170-065		100	015928	0,59

Art. EAN 4016671 EURO

70180 / 81



Abbrechklinge
Break-away blade
Lame détachable

ZN 82119400 PG 2
hochwertige, eisgehärtete Klinge aus Solingen 0,50 mm, für No. 70130, (zu 10 Stück im Dispenser), auch als Haken-Abbrechklinge erhältlich

0070180-000	100		015935	0,30
0070181-000	100	mit Haken	023046	0,73

70185



Dämmstoffklinge
Foamy Plastics Cutter Blade
Lame à couper plastiques cellulaire

ZN 82119400 PG 2
hochwertige, eisgehärtete Klinge aus Solingen, 140 mm lang

0070185-065	5		015942	3,30
-------------	---	--	--------	------

225



Pappreißmesser
Knife for slaters
Couteau pour couvreurs

ZN 82119200 PG 2
für Dachdecker

0022500	12	100 g, 205 mm	008005	14,85
---------	----	---------------	--------	-------

70140



Pappreißmesser
Cardboard tracing knife
Couteau-traceur à carton

ZN 82119300 PG 2
klappbar, mit Holzheft
can be folded
pliable

0070140-110	1		015881	11,40
-------------	---	--	--------	-------

70150



Kabelmesser
Cable knife
Couteau pour cable

ZN 82119300 PG 2
klappbar, mit Holzheft

0070150-000	1		015898	6,55
-------------	---	--	--------	------

70232



Dämmstoffmesser
Insulation knife
Couteau pour matériaux isolants

ZN 82119200 PG 2
doppelschneidig mit Säge- und Wellenschliff, für Glas- und Steinwolle, Klinge rostfrei und poliert, Holzgriff mit einseitigem Fingerschutz

0070232-280	1		022131	18,75
-------------	---	--	--------	-------

16 Zangen und Scheren Tongs and Shears Tenailles et Cisailles

Art. EAN 4016671 EURO

70510 - 13



Lochscherer
Punch Snip
Cisaille coupe-trous

ZN 82033000 PG 2
rechts oder links, aus Qualitäts- oder Edelstahl

For short and shaped cuts (large radii), available in right/left cutting versions

Bichantourneuse grands rayons et coupes courtes, coupe à droite ou coupe à gauche

0070510-250	5	rechts	015980	19,15
0070510-275	5	rechts	015997	20,80
0070510-300	5	rechts	016000	22,95
0070511-250	5	links	016017	19,15
0070511-275	5	links	016024	20,80
0070511-300	5	links	016031	22,65
0070512-250	5	rechts V2A	022377	29,45
0070512-275	5	rechts V2A	022384	33,30
0070513-250	5	links V2A	022391	29,45
0070513-275	5	links V2A	022407	33,30

70525 / 26



Rundlochscherer
Punch Snip with Curved Blades
Cisaille coupe-trous ronds

ZN 82033000 PG 2
rechts oder links, Schneiden rundgebogen für kreisförmige Schnitte, aus Edelstahl

Curved Blades - particularly suitable for circular cuts, available in right/left cutting versions

Lames courbes convenant particulièrement aux coupes circulaires, coupe à gauche

0070525-275	5	rechts V2A	016048	74,15
0070526-275	5	links V2A	016055	74,15

70540



Berliner Schere
Berlin pattern snip
Cisaille façon Berlin

ZN 82033000 PG 2
für lange gerade Schnitte, aus Qualitätsstahl
For long straight cuts, available in right cutting versions only

Coupe continue, uniquement coupe à droite

0070540-250	5		016109	17,25
0070540-300	5		016123	20,00

Art. EAN 4016671 EURO

70550 / 51



Figurenlochscherer
Shape Cutting Punch Snip
Cisaille bichantourneuse et coupe-trou

ZN 82033000 PG 2

rechts oder links, für kurze gerade und Figurenschnitte, aus Qualitätsstahl

For short straight and shaped cuts (Small radii), extra slim cutter head, available in right/left cutting versions

Bichantourneuse petits rayons et coupes courtes, tête de cisaille étroite, coupe à droite ou coupe à gauche

0070550-250	5	rechts	016130	19,50
0070551-250	5	links	016154	19,50

70560 - 63



Idealscherer
Shape and Straight Cutting Snip
Cisaille bichantourneuse et à coupe continue

ZN 82033000 PG 2

rechts oder links, für gerade durchlaufende und Figurenschnitte, aus Qualitäts- oder Edelstahl

For long straight and shaped cuts, available in right/left cutting versions

Bichantourneuse et coupes courtes, coupe à droite ou coupe à gauche

0070560-260	5	rechts	016178	36,15
0070560-280	5	rechts	016185	44,20
0070561-260	5	links	016192	36,15
0070561-280	5	links	016208	44,20
0070562-260	5	rechts V2A	022452	39,15
0070562-280	5	rechts V2A	022469	44,65
0070563-260	5	links V2A	022476	39,15
0070563-280	5	links V2A	022483	44,65

70570 - 73



Pelikanscherer
Tinmen's / Pelikan Snip
Cisaille passe tôle type Pélican

ZN 82033000 PG 2

rechts oder links, speziell für lange gerade durchlaufende Schnitte, aus Qualitäts- oder Edelstahl

For long straight sectioning cuts, available in right cutting version only (size 300 mm also available in left cutting version)

Coupe continue, uniquement coupe à droite

0070570-300	5	rechts	016215	32,25
0070570-350	5	rechts	016222	39,75
0070571-300	5	links	016239	32,25
0070572-300	5	rechts V2A	022490	43,35
0070573-300	5	links V2A	022506	43,35

Art. EAN 4016671 EURO

70580



Universalscherer
Universal Snip
Cisaille universelle

ZN 82033000 PG 2

für lange gerade und Figurenschnitte, aus Qualitätsstahl

For long straight and shaped cuts, available in right cutting version only

Bichantourneuse petits rayons et coupes courtes, uniquement coupe à droite

0070580-250	5		016246	24,35
-------------	---	--	--------	-------

70590



Universalscherer
Universal Snip with Wide Blade
Cisaille universelle avec une lame large

ZN 82033000 PG 2

mit breitem Blatt, für lange gerade und Figurenschnitte, aus Qualitätsstahl

For long straight and shaped cuts (large radii), available in right cutting version only

Bichantourneuse grands rayons et coupe continue, uniquement coupe à droite

0070590-250	5		016253	26,40
-------------	---	--	--------	-------

70600



Feder für Blechscherer
Springs for tin snips
ressort

ZN 82033000 PG 2

pour des bouts de bidon

0070600-000	1		022513	2,05
-------------	---	--	--------	------

70610 / 11



Figurenscherer
Aviation Snip
Cisaille bichantourneuse et à coupe continue

ZN 82033000 PG 2

rechts oder links, mit Hebelübersetzung, für kurze gerade und Figurenschnitte, aus Edelstahl

For short straight and shaped cuts, one blade finely serrated, available in right/left cutting versions

Tranchants cémentés en HSS, branches avec empieçement de matière souple, bichantourneuse et à coupe-continue, coupe à droite ou coupe à gauche

0070610-240	5	rechts	016260	36,15
0070610-260	5	rechts	016277	49,80
0070611-240	5	links	016284	36,15
0070611-260	5	links	016291	49,80

Art. EAN 4016671 EURO

70620 / 21



Idealschere
Shape and straight cutting snip
Cisaille bichantourneuse et à coupe continue

ZN 82033000 PG 2

rechts oder links, mit Hebelübersetzung, für kurze gerade und Figureschnitte, aus Edelstahl

For long straight and shaped cuts, one blade finely serrated, available in right / left cutting versions

Bichantourneuse et à coupe continue, pour coupes droites continues et pour figures, tranchants avec micro-dentures, coupe a droite ou coupe à gauche

0070620-240	5	rechts	016307	38,10
0070620-260	5	rechts	016314	50,45
0070621-240	5	links	016321	38,10
0070621-260	5	links	016338	50,45

70640



Idealschere
Shape and straight cutting snip
Cisaille bichantourneuse et à coupe continue

ZN 82033000 PG 2

rechts, mit Hebelübersetzung, für durchlaufende gerade und Figureschnitte, extrem kompakter Scherenkopf, praktische Riegel-Anschlag-Kombination, ergonomischer Griff, hervorragend geeignet für schwer zugängliche Stellen

0070640-180	1		026481	23,85
-------------	---	--	--------	-------

70685



Arbeitsschere
Industrial and professional shear
Ciseau de travail

ZN 82033000 PG 2

schwere Ausführung, langes und rundes Griffauge

Heavy duty type, black lacquered handles, extended finger grip

Version robuste, poignée laquée noire, avec un anneau allongé

0070685-250	6		016369	18,10
0070685-300	6		016376	27,45

Art. EAN 4016671 EURO

70686



Finny-Arbeitsschere
Industrial and professional shear
Ciseau de travail

ZN 82130000 PG 2

25 cm lang, bogenförmige Schneidenform für brillanten Schnitt und Leichtgängigkeit, bruchfeste Kunststoffgriffe mit rutschfester Weichgummi-Einlage in Signalfarbe Rot

FINNY ALPHA Household-/ textile- and carpet scissors, heavy household- and tailor's shears, 10" length, with special "BOTEC CUT" blades for exact and light cutting.; with unbreakable plastic handles with non slide soft inserts in bright red

0070686-250	1		023770	39,80
-------------	---	--	--------	-------

70691



Rohreinziehange
Pipe narrowing plier
Pince à réduction de tuyaux

ZN 82032000 PG 2

mit 5 Klingen; zum Verbinden von runden und eckigen Rohren; selbstöffnend, für rationelles Arbeiten; Einpresstiefe 30 mm

0070691-250	1		016390	39,65
-------------	---	--	--------	-------

70692



Rohreinziehange
Pipe narrowing plier
Pince à réduction de tuyaux

ZN 82032000 PG 2

Einpresstiefe 52 mm, optimale Übersetzung, 5 Schneiden gewährleisten exaktes Arbeiten und Verjüngung des Rohres um 9 mm im Radius

0070692-265	5		016406	94,65
-------------	---	--	--------	-------

70695



Handnietzange
Hand Riveting Tong
Pince à main

ZN 82055980 PG 2

aus Leichtmetall-Spezialguss pour pose de rivets

0070695-230	1		016413	50,10
-------------	---	--	--------	-------

70696



Gesipa-Handnietzange NTX
Gesipa Riveting Tong NTX
Gesipa pince à main

ZN 82055980 PG 2

bis Durchm. 5 mm (Alu), bis Durchm. 4 mm (Edelstahl)

pour pose de rivets NTX

0070696-260	1		021059	85,20
-------------	---	--	--------	-------

Art.			EAN 4016671	EURO
70697				
Gesipa-Handnietzange "Flipper" Gesipa Hand Riveting Tong "Flipper" Gesipa pince à main ZN 82055980 PG 2 reduzierte Betätigungskraft, mit Nietdorn-Auffangbehälter, großer Gesamthub (max. 16,2 mm) pour pose de rivets "Flipper"				
0070697-000		1	021066	102,90

Art.			EAN 4016671	EURO
70810				
Knipex-Kneifzange Carpenters' pincer Tenaille ZN 82032000 PG 2 aus Spezial-Werkzeugstahl, ölgehärtet de menuisier				
0070810-210		6	016420	18,75

Art.			EAN 4016671	EURO
70815				
Knipex-Monierzange (Rabitzzange) Tower Pincer Tenaille russe ZN 82032000 PG 2 Kopf poliert, Griff schwarz atramentiert				
0070815-220		6	016437	17,55
0070815-250		6	016444	19,55
0070815-280		6	016451	21,95

Art.			EAN 4016671	EURO
70816				
Knipex-Kraftmonierzange Tower Pincer Tenaille russe ZN 82032000 PG 2 vernickelt à forte multiplication				
0070816-300		6	016468	42,85

Art.			EAN 4016671	EURO
70830				
Knipex-Alligator Water Pump Plier "Alligator" Pince multiprises "Alligator" ZN 82032000 PG 2 aus CV-Elektrostahl, ölgehärtet, 7-fach verstellbar, optimale Hebelwirkung, mit durchgestecktem Gelenk Pipe grip ans spanner in one, Cr V., with box joint (pincas multiprise clé universelle en un seul outil), C. V., à charnière entrepassée				
0070830-250		6	016505	27,70

Art.			EAN 4016671	EURO
70835				
Knipex-Cobra Water Pump Plier Pince multiprises ZN 82032000 PG 2 mit durchgestecktem Gelenk, mit Einstellautomatik per Knopfdruck Cr V., with box joint, rapid adjustment by pressing button C. V., à charnière entrepassée, réglage par pression de l'ergot				
0070835-250		6	016512	34,70

Art.			EAN 4016671	EURO
70825				
Gripzange Grip Plier Pincas-étou ZN 82032000 PG 2 mit breitem Maul				
0070825-080		1	016482	31,85

Art.			EAN 4016671	EURO
70828				
Langlochzange Notch punching machine Pince à poinçonner en obang ZN 82032000 PG 2 mit verstellbarem Anschlag von 9 - 21 mm, Langlöcher 5 x 15 mm, Alu/Zink bis 0,8 mm, Eisenblech bis 0,8 mm, Kunststoff bis 1 mm ideal for cladding sheet coated with vinyl, zinc, aluminium idéale pour tôle de bardage revêue de vinyl, zinc, aluminium				
0070828-230		1	021097	79,70

Art.			EAN 4016671	EURO
71400				
Universalkoffer "Solar" Tool case for photovoltaics Mallette d'outils pour la photovoltaïque ZN 82060000 PG 2 bestückt mit: Universal-Abisolierzange, VDE-Kabelschere, Crimp-Systemzange mit Werkzeug zum Wechseln der Einsätze				
0071400-000		1	026054	371,60

Art.			EAN 4016671	EURO
71410				
Universal-Abisolierzange Universal Insulation Stripper Pince à dénuder universelle ZN 82032000 PG 2				
0071410-000		1	026061	133,00
0071410-900		1	Ersatzmesser 026078	64,40

Art.			EAN 4016671	EURO
71415				
			VDE-Kabelschere Cable Shear Coupe-câbles cuivre et aluminium	
			ZN 82033000 PG 2	
			Chrome-plated pliers, VDE-tested handles insulated with multi-component covers	
			Pince chromée, Branches isolées avec gaines à plusieurs composants, avec certification du VDE	
0071415-000		1	026085	48,90

Art.			EAN	EURO
71420 - 25				
			Crimp-Systemzange Crimp System Pliers Pince à sertir universelle	
			ZN 82032000 PG 2	
			mit Werkzeug zum Wechseln der Einsätze	
			for exchangeable crimping dies	
			pour profils de sertissage interchangeables	
0071420-000		1	026092	189,60
0071421-000		1	Crimpeinsatz H + S 026108	146,50
0071422-000		1	Crimpeinsatz MC 3 026115	164,35
0071422-900		1	Pos.-hilfe MC 3 026122	82,25
0071423-000		1	Crimpeinsatz MC 4 026139	173,40
0071423-900		1	Pos.-hilfe MC 4 026146	82,25
0071424-000		1	Crimp Hirschmann 026153	145,65
0071425-000		1	Crimp Solarlok 026160	250,00
0071425-900		1	Pos.-hilfe Solarlok 026177	82,25

17 Kellen Trowels Truelles

Art.			EAN	EURO
71010				
			Dänische Zungenkelle Tongue trowel Truelle de langue	
			ZN 82055910 PG 2	
			Grat poliert, konisch geschliffen, gehärtet	
			Danish type	
			façon Danemark	
0071010-160		10	016604	12,00

Art.			EAN	EURO
71020				
			Firstkelle Rooflayer's trowel Truelle de couvreur	
			ZN 82055910 PG 2	
			runde Schultern, Grat poliert, konisch geschliffen, gehärtet	
			round shoulders	
			épaule ronde	
0071020-190		10	016611	13,05

Art.			EAN 4016671	EURO
71025				
			Firstkelle Rooflayer's trowel Truelle de couvreur	
			ZN 82055910 PG 2	
			schräge Schultern, Grat poliert, konisch geschliffen, gehärtet	
			inclined shoulders in the back	
			épaules inclinées au bout	
0071025-180		10	016628	13,65

Art.			EAN	EURO
71030				
			Katzenzungenkelle Tongue shaped trowel Langue de chat	
			ZN 82055910 PG 2	
			Grat poliert, konisch geschliffen, gehärtet	
0071030-160		10	016635	11,70

Art.			EAN	EURO
71040				
			Hannoversche Dachkelle Rooflayer's trowel Truelle de couvreur	
			ZN 82055910 PG 2	
			Grat poliert, konisch geschliffen, gehärtet	
			Hannover type	
			façon Hannover	
0071040-030		10	016642	17,25

Art.			EAN	EURO
71050				
			Dänische Dachkelle Rooflayer's trowel Truelle de couvreur	
			ZN 82055910 PG 2	
			Grat poliert, konisch geschliffen, gehärtet	
			Danish type	
			façon Danemark	
0071050-030		10	016666	12,60

Art.			EAN	EURO
71055				
			Berliner Dachkelle Rooflayer's trowel Truelle de couvreur	
			ZN 82055910 PG 2	
			Grat poliert, konisch geschliffen, gehärtet	
			Berlin type	
			façon Berlin	
0071055-165		10	016673	18,15

Art.			EAN 4016671	EURO
71060				
				
Maurerkelle, S-Hals Mason's trowel Truelle de maçon ZN 82055910 PG 2 Grat poliert, konisch geschliffen, gehärtet German type, swans neck, blade square col de cygne				
0071060-160	10		016680	13,60

71070				
				
Biberschwanzkelle Rooflayer's trowel Truelle de couvreur ZN 82055910 PG 2 Grat poliert, konisch geschliffen, gehärtet beavertail-pattern façon queue de castor				
0071070-170	10		016703	18,15

18 Mess- und Anreißwerkzeuge
Measuring and Scribing Tools
Outils à mesurer et à tracer

71501				
				
Zimmermannsbleistift Carpenter's pencil Crayon pour charpentier ZN 96091010 PG 2 25 cm, rot				
0071501-025	72		016758	1,20

71510				
				
Holzgliedermaßstab "PICARD" Wooden folding rule Mètre pliant en bois ZN 90178010 PG 2 aus Buchenholz, schwarze Teilung, rote Dezimalzahlen, innenliegende, wartungsfreie Polyamid-Gelenke, 2 m with spring avec ressort				
0071510-000	10		016765	5,20

71521				
				
Glasfasermaßband Fibre glass measuring tape Ruban de mesure ZN 90178010 PG 2 lederüberzogene Metallkapsel				
0071521-020	1	20 m	016826	23,40
0071521-030	1	30 m	016833	34,35
0071521-050	1	50 m	016840	70,50

Art.			EAN 4016671	EURO
71524				
				
Stahlbandmaß HiLock ZN 90178010 PG 2 5 Meter, Stopper, mit Gürtelclip, stark bombierte Bänder, ausgewogene Formgebung, kompaktes Design				
0071524-005	1		025248	11,55

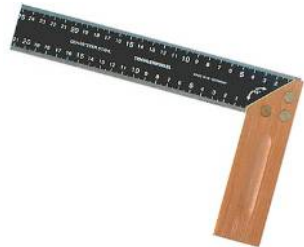
71530				
				
Schreinerwinkel Joiner's Square Equerre de menuisier ZN 90172019 PG 2 mit Buchenholzschenkel, Stahlblatt 42 mm, mit Gehrung with beech wood stock, and blue steel blade avec côtes en bois de hêtre et ferrures en acier bleu				
0071530-400	6		016918	25,75

71531				
				
Tischlerschmiege Adjustable Sliding Bevel Sauterelle de menuisier-ébéniste ZN 90172019 PG 2 mit Messingbeschlag with wing nut and wooden stock avec côtés en bois de hêtre et ferrures en laiton				
0071531-300	6		016925	31,25

71532				
				
Zimmermannswinkel Carpenter's square w. holes Equerre de charpentiers avec trou ZN 90172019 PG 2 mit zwei Maßen, Anreißlöcher mit mm- Einteilung, pulverbeschichtet powder covered with marking holes and 2 graduations in black colour revêtement par poudre avec deux échelles de mesure et orifices de tracage				
0071532-700	1	700 x 300	016932	36,10
0071532-800	1	800 x 320	016949	37,45

71533				
				
Anschlagwinkel Steel Square with back Equerre à butée ZN 90172019 PG 2 glanzverzinkt zinc plated galvanisée brillant				
0071533-250	1	250 x 160	016956	21,25
0071533-300	1	300 x 180	016963	26,30

Art.			EAN 4016671	EURO
71535	ALPHA-Anreißgerät ALPHA-Marking device Tracoir ALPHA			
	ZN 90172019 PG 2 Winkel, Stellschmiege und Winkelmesser in einem; aus rostfreiem Federbandstahl für das Messen und Anreißen im Holzbau; bei Versätzen, Kerfen, Schiftungen und vielem anderen mehr, Schenkellänge 800 x 320 mm			
0071535-800	1	800 x 320	024517	154,00

Art.			EAN 4016671	EURO
71536	COTTA-Anreißgerät COTTA-Marking device Tracoir COTTA			
	ZN 90172019 PG 2 aus gehärtetem Federbandstahl, pulverbeschichtet, Schenkellänge 800 x 320 mm powder covered revêtement par poudre			
0071536-800	1	800 x 320	016987	154,00

Art.			EAN 4016671	EURO
71540	Lattenstichmaß Batten Gauge Mesure d'écartement pour lattes			
	ZN 82055910 PG 2 aus Aluminium, Skala bis 40 cm, zum genauen Verlegen der Dachlatten			
0071540-400	1		016994	17,05

Art.			EAN 4016671	EURO
71545	Lattenstichmaß Batten Gauge Mesure d'écartement pour lattes			
	ZN 82055910 PG 2 U-Profil, mit Fallsicherung			
0071545-400	1		020571	53,30

Art.			EAN 4016671	EURO
71550	Wasserwaage Spirit level Niveau à eau			
	ZN 90318059 PG 2 aus Leichtmetall, hohe Maßgenauigkeit, gelb pulverbeschichtet Aluminium en métal léger			
0071550-040	1		017007	18,85
0071550-050	1		017014	21,20
0071550-060	1		017021	22,10
0071550-080	1		017038	25,15
0071550-100	1		017045	28,25
0071550-150	1		017052	49,70
0071550-200	1		017069	64,75

Art.			EAN 4016671	EURO
71551	Schnurwasserwaage Cord spirit level Niveau à eau			
	ZN 90318059 PG 2			
0071551-000	1		017076	11,25

Art.			EAN 4016671	EURO
71560	Spitzzirkel Compass Compas			
	ZN 90172030 PG 2 aus Stahl, poliert			
0071560-200	1		017083	17,15
0071560-250	1		017090	24,25
0071560-300	1		017106	29,70

Art.			EAN 4016671	EURO
71565	Bogenzirkel Compass Compas			
	ZN 90172030 PG 2 aus Stahl, poliert			
0071565-200	1		017113	25,10
0071565-250	1		017120	33,15
0071565-300	1		017137	42,25

Art.			EAN 4016671	EURO
71567	Reißnadel Scribing iron Pointe à tracer			
	ZN 74151000 PG 2 aus CV-Stahl, Spitzen gehärtet und feinst geschliffen			
0071567-230	1		021998	5,75

Art.			EAN 4016671	EURO
71568	Anreißschablone Scriber Tracette à zinc			
	ZN 72201200 PG 2 stabile Ausführung, aus rostfreiem Stahl, mit genauer Maßeinteilung von 5 - 100 mm, um 5 mm steigend marking tool			
0071568-000	1		022018	16,15

Art.			EAN 4016671	EURO
71572	Schnurschlaggerät Chalk line reel Cordeau à tracer			
	ZN 90172039 PG 2 stabiles Propylengehäuse, 30 m Schnur			
0071572-030	10		017144	10,05

Art.			EAN 4016671	EURO
71573				
			Schnurschlaggerät Chalk line reel Cordeau à tracer	
			ZN 90178090 PG 2	
			aus Alu-Druckguss, mit 20 m Schnur, mit Metallspitze, kann auch als Senklot verwendet werden	
0071573-020		20	017151	12,75

71574				
			Schnurschlaggerät Chalk line reel Cordeau à tracer	
			ZN 90178090 PG 2	
			leichte Ausführung aus Alu, 15 m Schnur en métal léger	
0071574-020		1	017168	8,65

71670				
			Schnurschlaggerät "Rapido" Chalk line reel "Rapido" Cordeau à tracer "Rapido"	
			ZN 90172039 PG 2	
			ermöglicht schnelles Einrollen der Schnur, Übersetzung 3:1, 30 m Schnur	
0071670-030		10	017281	17,80

71671				
			Schnurschlaggerät "Cosmos" Chalk line reel "Cosmos" Cordeau à tracer "Cosmos"	
			ZN 90172039 PG 2	
			aus Alu-Druckguss, besonders ergonomische Form, mit extrem schnellem Einzug, 30 m Schnur	
			Alu, 30 m	
			Alu, 30 m	
0071671-030		12	020885	21,20

71676				
			Zimmererschnurschlag Carpenters chalk line Cordeau de charpentier double	
			ZN 90172039 PG 2	
			doppelt, 2 Kunststoffgehäuse mit Klemmverschluss, wechselseitige Schnureinfärbung rationalisiert das Arbeiten, 30 m Schnur	
0071676-030		5	017298	19,20
0071676-900		1	Ersatzkordel 022155	4,90

Art.			EAN 4016671	EURO
71677				
			Zimmererschnurschlag Carpenters chalk line Cordeau de charpentier double	
			ZN 90172039 PG 2	
			doppelt, 2 Kunststoffgehäuse mit Klemmverschluss, wechselseitige Schnureinfärbung rationalisiert das Arbeiten, 30 m Schnur, mit Griffen	
0071677-030		1	022872	20,05

71575 - 77				
			Nachfüllkreide Replacement chalk powder Poudre de tracage	
			ZN 96099090 PG 2	
			blau, rot oder weiß, gut haftend, in Plastikflasche mit Einfüllstutzen	
0071575-001	12	blau, 1000 g	017175	12,20
0071575-100	6	blau, 100 g	017199	3,05
0071575-200	6	blau, 200 g	017205	5,20
0071575-400	6	blau, 400 g	017212	6,75
0071576-001	12	rot, 1000 g	017229	12,20
0071576-100	6	rot, 100 g	017243	3,05
0071576-200	6	rot, 200 g	017250	5,20
0071576-400	6	rot, 400 g	017267	6,75
0071577-200	12	weiß, 200 g	022803	5,20

71579				
			Ersatzkordel Refill Line Cordeau de rechange	
			ZN 90178090 PG 2	
			für Schnurschlaggeräte	
			in skein 30m/1mm	
			Carotte polycotton tresse 30m/1mm	
0071579-030		1	017274	4,70

71580				
			Maurerschnur Plumb line Cordeau de maçon	
			ZN 54025910 PG 2	
			2 mm stark	
0071580-050		6	020168	8,50

19 Sägen und Sägeblätter Saws and Saw Blades Scies et Lames de scie

Art.			EAN 4016671	EURO
72010				
Dachdeckersäge Roofers' saw Scie de couvreurs				
ZN 82021000 PG 2 aus Elektrostahl, geschärft und geschärft, lackierter Holzgriff, vernickelte Nieten curved à chantourner				
0072010-420	6		017311	22,25
72020				
Handsäge Hand saw Scie égoïne				
ZN 82021000 PG 2 aus Spezialstahl, grobe Zahnung, lackierter Holzgriff, vernickelte Nieten				
0072020-400	6		017328	10,30
72030				
Stichsäge Compass-saw Scie à guichet				
ZN 82021000 PG 2 aus Spezialstahl, extra starke Ausführung, lackierter Holzgriff, Blatt 300 mm				
0072030-380	6		017335	9,20
72040				
Dämmstoffsäge Styrofoam saw Scie pour plaque isolante				
ZN 82021000 PG 2 aus Spezialstahl, extra feine Zahnung für Hartschaum, Styropor usw., Blatt 380 mm				
0072040-300	6		017342	20,70
72050				
Klein-Bügelsäge Bow saw Scie à bûches				
ZN 82021000 PG 2 ovaler Bügel, mit Spannhebel (inkl. 1 Blatt für Holz)				
0072050-530	1	mit Holzblatt	017366	19,00
0072080-530	1	Ersatzblatt Metall	025767	4,85
0072090-530	1	Ersatzblatt Holz	017397	2,80

Art.			EAN 4016671	EURO
72051				
Einmann-Bügelsäge Bow saw Scie à bûches				
ZN 82021000 PG 2 ovaler Bügel, mit Spannhebel (inkl. 1 Blatt für Holz)				
0072051-762	1	mit Holzblatt	017373	16,35
0072081-762	1	Ersatzblatt Metall	025187	6,80
0072091-762	1	Ersatzblatt Holz	017403	3,05

Art.			EAN 4016671	EURO
72052				
Rohrsäge Special-bow-saw Scie à bûches idéale				
ZN 82021000 PG 2 mit Metall- und Holzägeblatt, für Durchm. bis 130 mm for pipes pour tubes				
0072052-300	1		017380	15,00
0072092-300	10	Ersatzblatt Holz	020366	3,00

Art.			EAN 4016671	EURO
72110 / 15				
Metallsägebogen Junior hack saw Scie à métaux				
ZN 82021000 PG 2 mit Blatt, leichte Ausführung in Spitzenqualität, für Holz und Metall, Blattlänge 146 mm petite				
0072110-000	1		017410	10,40
0072115-000	1	spitze Ausführung	026276	10,40
0072295-000	12	Ersatzblatt Holz	017465	0,49
0072296-000	12	Ersatzblatt Metall	017472	0,49

Art.			EAN 4016671	EURO
72120				
Metallsägebogen Hacksaw frame Arc de scie à métaux				
ZN 82021000 PG 2 schwere Ausführung mit Blatt, Bügel aus lackiertem Walzstahl, für Blätter in 300 mm, Gesamtlänge 520 mm heavy quality lourd				
0072120-300	1		017427	14,85

Art.			EAN 4016671	EURO
72130				
Metallsägebogen Hacksaw frame Arc de scie à métaux				
		ZN 82021000	PG 2	
mit Pistolengriff, mit Blatt, Griff aus lackiertem Leichtmetalldruckguss, mit Sägeblattreserve, Gesamtlänge 425 mm				
heavy quality				
lourd				
0072130-300		1	017434	14,80

Art.			EAN 4016671	EURO
72290				
Ersatzblatt Hack saw blade for metal Lame pour métal				
		ZN 82029919	PG 2	
HSS biMetall, 24 Zähne, einseitig, für Sägebogen No. 72120, 72130, 72052				
0072290-300		100	017441	1,80

Art.			EAN 4016671	EURO
72291				
Ersatzblatt Hack saw blade for metal Lame pour métal				
		ZN 82029919	PG 2	
doppelseitige Sägeblätter aus hochwertigem Kohlenstoffstahl, 24 Zähne				
0072291-300		100	017458	1,95

Art.			EAN 4016671	EURO	
72060					
Japansäge mit langem Griff precision cross-cut saw Scie japonaise					
		ZN 82021000	PG 2		
klassische Zugsäge mit geradem Griff in Kunststoff-Ausführung, Sägeblätter schnell wechselbar, Blattlänge 265 mm					
with quick-release blade retainer, elastomer grip					
265 mm, manche droit en caoutchouc					
0072060-265		1	024371	34,45	
0072093-265		1	Ersatzblatt	024395	10,70
0072093-300		1	Ersatzblatt	024401	11,80

Art.			EAN 4016671	EURO
72061				
Japansäge mit Pistolengriff precision cross-cut saw Scie japonaise				
		ZN 82021000	PG 2	
Zugsäge mit Kreuz-Schnitt, kraftsparend, Sägeblätter schnell wechselbar, Blattlänge 265 mm				
with quick-release blade retainer				
265 mm, manche pistolet				
0072061-265		1	024388	25,35

Art.			EAN 4016671	EURO	
72062					
Japan-Klappsäge folding blade saw Scie pliable					
		ZN 82021000	PG 2		
mit Schnellschnitt-Sägeblatt, Blattlänge 240 mm					
with elastomer grip, 240 mm					
avec grip elastomère, 240 mm					
0072062-240		1	025255	28,55	
0072097-240		1	Ersatzblatt	025682	6,75

Art.			EAN 4016671	EURO	
72063					
Aluminium-Japansäge G-SAW ALUMINIST type Scie pliable					
		ZN 82021000	PG 2		
Blattlänge 240 mm					
240 mm					
avec lame noire, 240 mm					
0072063-240		1	025262	34,45	
0072096-240		1	Ersatzblatt	025668	12,60

20 Bits und Zubehör

Bits

Bits

Art.			EAN 4016671	EURO
72431				
Dachdecker Bit-Check Kombi Bit-Safe Bit-boîte safe				
		ZN 99908200	PG 2	
8000-6/TZ, 7-teilig, Inhalt: je 1 Stück 1,0 x 5,5; 1,2 x 6,5; PH1; PH2; PZ1; PZ2; 895/4/1 K				
7 parts				
7 pièces				
0072431-007		1	021509	24,00

Art.			EAN 4016671	EURO
72432				
Dachdecker Bit-Check Pozidriv Bit-Safe Bit-boîte safe				
		ZN 99908200	PG 2	
8055-6/TH, 7-teilig, Inhalt: 2 x PZ1; 3 x PZ2; 1 x PZ3; 1 x 895/4/1 K				
7 parts				
7 pièces				
0072432-007		1	021516	24,75

Art.			EAN 4016671	EURO
------	--	--	----------------	------

72433



**Dachdecker Bit-Check TORX
Bit-Safe
Bit-boîte safe**

ZN 99908200 PG 2

8067-6 BO/Z, 7-teilig, Inhalt: je 1 Stück TX10; TX15; TX20; TX25; TX30; TX40; 894/4/1 K

7 parts
7 pièces

0072433-007	1		021523	39,05
-------------	---	--	--------	-------

Art.			EAN 4016671	EURO
------	--	--	----------------	------

72482



**Mini-Check
Bit-Safe
Bit-boîte safe**

ZN 82079030 PG 2

7-teilig, Inhalt: je 1 Stück 1,0 x 5,5; 1,2 x 6,5; PH1; PH2; PZ1; PZ2; 893/4/1 K

7 parts
7 pièces

0072482-007	1	neu!	026559	12,45
-------------	---	------	--------	-------

Art.			EAN 4016671	EURO
------	--	--	----------------	------

72483



**Mini-Check TX
Bit-Safe
Bit-boîte safe**

ZN 82079030 PG 2

7-teilig, Inhalt: je 1 Stück TX10; TX15; TX20; TX25; TX30; TX40; 893/4/1 K

7 parts
7 pièces

0072483-007	1	neu!	026566	16,15
-------------	---	------	--------	-------

Art.			EAN 4016671	EURO
------	--	--	----------------	------

72450



**Phillips-Bit
Bit-Safe
Bit-boîte safe**

ZN 82079030 PG 2

851/1 Z

0072450-001	10	PH 1 x 25 mm	021530	1,55
0072450-002	10	PH 2 x 25 mm	021547	1,55
0072450-003	10	PH 3 x 25 mm	021554	1,55

Art.			EAN 4016671	EURO
------	--	--	----------------	------

72455



**Pozidriv-Bit
Bit-Safe
Bit-boîte safe**

ZN 82079030 PG 2

855/1 Z

0072455-001	10	PZ 1 x 25 mm	021578	1,55
0072455-002	10	PZ 2 x 25 mm	021585	1,55
0072455-003	10	PZ 3 x 25 mm	021592	1,55
0072455-004	10	PZ 4 x 32 mm	021608	4,45

Art.			EAN 4016671	EURO
------	--	--	----------------	------

72460



**TORX-Bit
Bit-Safe
Bit-boîte safe**

ZN 82079030 PG 2

867/1 Z

0072460-010	10	TX 10 x 25 mm	021615	4,00
0072460-015	10	TX 15 x 25 mm	021622	4,00
0072460-020	10	TX 20 x 25 mm	021639	4,00
0072460-025	10	TX 25 x 25 mm	021646	4,00
0072460-030	10	TX 30 x 25 mm	021653	4,00
0072460-040	10	TX 40 x 25 mm	021660	4,00

Art.			EAN 4016671	EURO
------	--	--	----------------	------

72490



**Schnellwechselhalter mit Magnet
Magnetic bit holder
Porte magnétique bit**

ZN 84661039 PG 2

895/4/1 K

0072490-000	1	1/4" x 52 mm	021677	21,65
-------------	---	--------------	--------	-------

Art.			EAN 4016671	EURO
------	--	--	----------------	------

72475



**Bit-Check Edelstahl
Bit-Check, stainless**

ZN 82079030 PG 2

BC 12/9, 1 Edelstahl-Halter Rapidaptor 3888/4/1K zur Aufnahme in die Schraubmaschine oder zum Einsatz in das Bohrfutter der elektronischen Bohrmaschine.

0072475-010	1		025378	56,00
-------------	---	--	--------	-------

Art.			EAN 4016671	EURO
------	--	--	----------------	------

72476



**Bit-Check Edelstahl
Bit-Check, stainless**

ZN 82079030 PG 2

BC 10/9, 1 Edelstahl-Halter Rapidaptor 3888/4/1K mit Schnellwechselfutter, zur Aufnahme in die Schraubmaschine oder zum Einsatz in das Bohrfutter der elektronischen Bohrmaschine.

0072476-010	1		025385	56,00
-------------	---	--	--------	-------

Art.			EAN 4016671	EURO
------	--	--	----------------	------

72472



**TORX-Bit
TORX-Bit, stainless
Bit-boîte safe**

ZN 82079030 PG 2

Edelstahl, 3867/1 TS

0072472-020	10	TX 20 x 25 mm	025316	4,50
0072472-025	10	TX 25 x 25 mm	025323	4,50
0072472-030	10	TX 30 x 25 mm	025330	4,50
0072472-040	10	TX 40 x 25 mm	025347	4,50

Art.			EAN 4016671	EURO
72474				
Rapidaptor Universalhalter Rapidaptor Universal Bit Holder, stainless Adaptateur universel Rapidaptor, acier inoxydable ZN 84661038 PG 2 Edelstahl, 3888/4/1 K, C + E 6,3, mit Schnellwechselfutter				
0072474-000		5	025361	29,50

Art.			EAN	EURO
72480 / 81				
High Tech Schrauben-Löser / Edelstahl-Protector high-tech screw releaser / stainless steel protector dérippant de boulons / protecteur pour acier inoxydable ZN 27101190 PG 2 Aerosoldose 400 ml, (Edelstahl-Protector = ZN 34059010)				
0072480-400		6	Schrauben-Löser 025156	11,80
0072481-400		6	Edelstahl-Protector 025712	13,20

21 Beile, Äxte und Hammertacker
Hatchets, Axes and Hammertackers
Hachettes, Haches, Marteaux à agrafes

Art.			EAN	EURO
72510				
Kirschen-Stechbeitel Firmer chisel Ciseau à bois ZN 82053000 PG 2 kurz, leicht, mit Seitenfasen und abgeflachtem Weißbuchenheft short lenght, light pattern, bevelled edges, with flat white beech handle modèle léger, biseauté, avec manche plat en bois de charme				
0072510-020		6	20 mm 017571	24,25
0072510-022		6	22 mm 022292	27,40
0072510-026		6	26 mm 017588	27,40
0072510-030		6	30 mm 022308	31,35

Art.			EAN 4016671	EURO
72515				
Kirschen-Zimmermannsbeitel Carpenters' Chisel Ciseau à bois ZN 82053000 PG 2 halblange, schwere, extra starke Form mit Seitenfasen, schwerem, rundem Weißbuchenheft und Lederscheibe halflong, heavy pattern, extra strong, bevelled edges with heavy, round hornbeam handle and leather disc pour charpentiers, demi-long, lourde, exécution extra-forte, biseauté avec manche lourd rond en charme et rondelle cuir				
0072515-020		2	20 mm 022315	43,55
0072515-026		2	26 mm 017595	50,30
0072515-030		2	30 mm 017601	55,00
0072515-035		2	35 mm 022339	74,75
0072515-040		2	40 mm 022346	78,65

Art.			EAN	EURO
72520				
Handbeil Hatchet Hachette ZN 82014000 PG 2 mit poliertem Kuhfußstiel aus Esche, Schneide poliert				
0072520-600		1	ES 017618	21,50

Art.			EAN	EURO
72523				
Zimmermannsbeitel Carpenter's hatchet Hachette de charpentiers ZN 82014000 PG 2 Schwäbische Form, mit angeschmiedeter Nagelklaue, Schneide beidseitig angeschliffen und poliert, Stiel aus Esche (Schneidenbreite 120 mm)				
0072523-120		1	ES 1100 g 017649	77,95

Art.			EAN	EURO
72524				
Zimmermannsaxt Axe Hache ZN 82014000 PG 2 Schneide poliert, mit angeschmiedeter Nagelklaue und poliertem geradem Eschenstiel				
0072524-800		1	ES 1400 g 017656	87,40

Art.			EAN	EURO
72542				
Zimmermannsaxt "Standard" Axe Hache ZN 82014000 PG 2 mit poliertem Kuhfußstiel aus Esche, Schneide poliert				
0072542-800		1	ES 1600 g 022193	49,45

Art.			EAN 4016671	EURO
72530				
Zugmesser Drawing Knife Couteau				
			ZN 82019000	PG 2
			gerade Form	
0072530-225		1	017663	39,05

Art.			EAN 4016671	EURO
72531				
Zugmesser Drawing Knife Couteau				
			ZN 82019000	PG 2
			gebogene Form	
0072531-225		1	017670	59,90

Art.			EAN 4016671	EURO
72535				
Stichaxt Mortice Axe Ciseau de charpentier				
			ZN 82014000	PG 2
			Chrom-Vanadium-Stahl, mit Seitenfasen	
0072535-450		1	450 x 45 mm	017687 67,70

Art.			EAN 4016671	EURO
72610				
Hammer-Tacker Hammer tacker Marteau à agrafes				
			ZN 82055980	PG 2
			Rapid 19, leichte Ausführung für Kunststofffolien, Dampfsperren, Etiketten	
0072610-019		1	360 g	017793 48,30

Art.			EAN 4016671	EURO
72620				
Hammer-Tacker Hammer tacker Marteau à agrafes				
			ZN 82055980	PG 2
			Rapid 11, schwere Ausführung für Dachpappe, Unterspannbahnen, Isolierungen usw.	
0072620-011		1	960 g	017809 97,70

Art.			EAN 4016671	EURO
72630				
Hammer-Tacker Hammer tacker Marteau à agrafes				
			ZN 82055980	PG 2
			Rapid 54, besonders stabile Ausführung für höchste Beanspruchung	
0072630-054		1	1130 g	017816 135,00

Art.			EAN 4016671	EURO
72690 - 97				
Heftklammern Staples Agrafes				
			ZN 83052000	PG 2
			Preis für 5000 Stck.	
0072690-000		1	37/6 R19/23/33	017823 8,25
0072691-000		1	11/10 R11/54	017830 12,95
0072696-000		1	11/6 R11	020229 10,20
0072697-000		1	11/8 R11/54	020236 10,85

22 Pinsel, Spachtel usw. Brushes, Scrapers, etc. Brosses, Spatules, etc.

Art.			EAN 4016671	EURO
75010 / 12				
Salzsäureflasche Hydrochloric acid bottle Flacon pour acide chlorhydrique				
			ZN 39233010	PG 2
			aus Polyäthylen, blau	
0075010-150		1		017878 5,35
0075012-150		1	mit Auslaufschutz	025651 12,35

Art.			EAN 4016671	EURO
75011 / 13				
Lötwasserflasche Soldering fluid bottle Flacon pour eau à souder				
			ZN 39233010	PG 2
			aus Polyäthylen, gelb	
0075011-150		1		017885 5,35
0075013-150		1	mit Auslaufschutz	025200 12,35

Art.			EAN 4016671	EURO
75020				
Lötsalmiakstein Ammonia stone Pierre à souder				
			ZN 38109090	PG 2
			in Plastikdose for soldering	
0075020-100		1	100 x 45 x 20 mm	017908 3,45

Art.			EAN 4016671	EURO
75030				
Lötwasserpinsel Soldering fluid brush Pinceau de décapage				
			ZN 96034010	PG 2
			für Öl, Lacke, Säuren usw.	
0075030-100		25	10 mm	017915 0,65

Art.			EAN 4016671	EURO
75040				
			Flachpinsel Varnish brush Queue de morue	
			ZN 96034010	PG 2
			Handwerkerqualität	
0075040-015	12	1,5"	017922	1,25
0075040-020	12	2" 50 mm	017939	1,45
0075040-030	12	3" 70 mm	017946	2,95

75050				
			Flachpinsel Radiator brush Brosse pour radiateurs	
			ZN 96034010	PG 2
			gebogen, Handwerkerqualität	
0075050-020	1	2" 50 mm	017960	1,75

75055				
			Ringpinsel Paint brush Brosse persienne industrielle	
			ZN 96034010	PG 2
0075055-002	12	Größe 2	021721	0,85
0075055-004	12	Größe 4	021738	1,20
0075055-006	12	Größe 6	021745	1,50
0075055-008	12	Größe 8	021752	2,00
0075055-010	12	Größe 10	021769	2,75

75060				
			Stahldrahtbürste Steel wire brush Brosse à manche en fil d'acier	
			ZN 82055910	PG 2
			5-reihig	
			5 rows	
			5 lignes	
0075060-005	1	280 mm	017977	2,60

75061				
			Messingdrahtbürste Brass wire brush Brosse en fil de laiton	
			ZN 82055910	PG 2
			4-reihig	
			4 rows	
			4 lignes	
0075061-004	1	280 mm	017984	6,80

75070				
			Auspresspistole Caulking gun Pistolet au cartouche	
			ZN 82055910	PG 2
			halboffene Form, lackiert	
0075070-000	1		017991	5,85

Art.			EAN 4016671	EURO
75071				
			Auspresspistole Caulking gun Pistolet au cartouche	
			ZN 82055910	PG 2
			Skelettform	
0075071-001	1		018035	11,00

75072				
			Auspresspistole Caulking gun Pistolet au cartouche	
			ZN 82055910	PG 2
			geschlossene Form, Aluminium-Körper	
0075072-002	1		018042	49,25

75073				
			Auspresspistole Caulking gun Pistolet au cartouche	
			ZN 82055980	PG 2
			Convoy Just, extralange Kartuschenpresse, mit 360° Rotations-Trommel	
0075073-003	1		025279	18,25

75075				
			Malerspachtel Painters' Scraper Couteau de peintre	
			ZN 82055910	PG 2
			Industriequalität, eingesteckte Klinge, mit lackiertem ovalem Heft	
0075075-030	10		018059	2,20
0075075-040	10		022742	2,25
0075075-050	10		018066	2,35
0075075-060	10		023213	2,50
0075075-070	10		018073	2,65
0075075-100	10		018080	3,25

75081				
			Multifunktion-Klinge / Schaber	
			ZN 82055910	PG 2
			Universal-Schaber aus einem Stück Edelstahl geformt, mit Schlagkappe, extrastarke, wärmebehandelte und gehärtete Klinge mit 1,8 mm	
0075081-000	1		025286	19,95

Art. EAN 4016671 EURO

75085



Andrückrolle
Pressure roller
Rouleau de pression

ZN 82055910 PG 2
für Überlappschweißungen, aus Gummi,
beidseitig gelagert

0075085-050 1 022001 19,80

75086



Andrückrolle
Pressure roller
Rouleau de pression

ZN 82055910 PG 2
für Überlappschweißungen, aus Stahl,
einseitig gelagert

0075086-040 1 022582 56,35

75087



Andrückrolle
Pressure roller
Rouleau de pression

ZN 82055910 PG 2
für Überlappschweißungen, aus Silicon,
einseitig gelagert

0075087-045 1 022834 37,75

72800



Universalbohrer GOLDCRAFT
Universal Drill Bits GOLDCRAFT

ZN 82075030 PG 2
spezielle Schneidengeometrie,
diamantgeschliffene Schneidflächen der
Hartmetallplatte, für fast alle Bohrmaterialien
geeignet, sehr harte Wolfram-Titan-
Hartmetallspitze, extrem verschleißfest

0072800-030	1	3 x 70 x 40	025415	3,95
0072800-040	1	4 x 75 x 40	025422	3,85
0072800-050	1	5 x 85 x 50	025439	4,20
0072800-060	1	6 x 100 x 60	025446	4,60
0072800-080	1	8 x 120 x 80	025453	5,65
0072800-100	1	10 x 120 x 80	025460	7,50
0072800-120	1	12 x 150 x 90	025477	10,20

72810



Fliesen- / Ziegelbohrer KERAMIK
Tile / Brick Drill Bits KERAMIK

ZN 82075030 PG 2
mit TSM HM-Platte, für Stahl, Metall, Ziegel
und Ton; Trockenbohren bis Ritzhärte 9,
diamantgeschliffene Spezialhartmetallplatte,
Wolfram-Titan-Spitze
with TSM carbide tip

0072810-040	1	4 x 75 x 40	025484	4,60
0072810-050	1	5 x 85 x 50	025491	4,95
0072810-060	1	6 x 100 x 60	025507	5,55
0072810-080	1	8 x 120 x 80	025514	6,75
0072810-100	1	10 x 120 x 80	025521	8,90
0072810-120	1	12 x 150 x 90	025538	12,15
0072810-140	1	14 x 150 x 90	025545	14,50

23 Lederartikel, Werkzeugkoffer
Leather Articles, Tool Boxes
Articles en Cuir, Caisses d'outils

Art. EAN 4016671 EURO

306



Werkzeugkette
Tool holder
Lanière

ZN 42029180 PG 2
3-teilig, mit Lederschlaufen
for carrying tools on belt
pour porter des outils

0030600 1 75 g 008043 3,60

306a



Löwenkopfkette
Tool holder
Lanière

ZN 42029180 PG 2
3-teilig
for carrying tools on belt
pour porter des outils

0030610 1 180 g 015027 18,40

306b



Swinger
Tool holder
Lanière

ZN 42029180 PG 2
Hammerhalter mit Metallbügel
for carrying tools on belt
pour porter des outils

0030620 1 70 g 015034 7,10

306c



Zangenschlaufe
Tool holder
Lanière

ZN 42029180 PG 2
aus Leder
for carrying tools on belt
pour porter des outils

0030630 1 021103 3,75

306 1/2



Hammerschlaufe
Leather tool holder
Lanière en cuir

ZN 42029180 PG 2
aus Leder
for carrying tools on belt
pour porter des outils

0030690 1 50 g 008050 3,80

Art.			EAN 4016671	EURO
307				
Messerscheide Leather tool holder Lanière en cuir				
ZN 42029180 PG 2 aus Leder, für Universalmesser for carrying knives on belt pour porter des couteaux				
0030700	1	60 g	008067	4,70

307a				
Messerscheide Leather tool holder Lanière en cuir				
ZN 42029180 PG 2 aus Leder, für Universalmesser, Halfterform for carrying knives on belt pour porter des couteaux				
0030710	1	60 g	015041	6,85

307b				
Dämmstoffmesserscheide Leather tool holder Lanière en cuir				
ZN 42029180 PG 2 aus Leder for carrying knives on belt pour porter des couteaux				
0030720	1		021110	5,25

308				
Nageltasche Nail Purse Poche				
ZN 42029180 PG 2 aus Leder, 1 Fach for Slaters pour couvreurs				
0030800	1	100 g	008074	9,30

310				
Nageltasche Nail Purse Poche				
ZN 42029180 PG 2 aus Leder, 2 Fächer for Slaters pour couvreurs				
0031000	1	160 g	008081	12,35

Art.			EAN 4016671	EURO
311				
Lederkoppel Leather belt Ceinture en cuir				
ZN 42029180 PG 2 ohne Koppelschloss				
0031100-0800	1		008098	9,65
0031100-0850	1		015058	9,65
0031100-0900	1		008104	9,65
0031100-0950	1		015065	9,65
0031100-1000	1		008111	9,65
0031100-1050	1		015072	9,65
0031100-1100	1		008128	9,65
0031100-1150	1		015089	9,65
0031100-1200	1		008135	9,65

311a - f				
Koppelschloss Buckle for belts Boucle de ceinture				
ZN 83089000 PG 2 verschiedene Ausführungen, 40 g				
0031110	1	neutral	008142	5,95
0031120	1	Dachdecker	008159	6,90
0031130	1	Zimmerer	008166	6,90
0031140	1	Maurer	008173	6,90
0031150	1	Klempner	019827	6,90
0031160	1	Tischler	019834	6,90

315				
Nagelschürze Nail Apron for Slaters Tablier pour couvreurs				
ZN 42029180 PG 2 für Dachdecker, 500 x 300 mm				
0031500	1	540 g	008180	42,05

315a				
Spezialgürtel Nail Apron for Slaters Tablier pour couvreurs				
ZN 42029180 PG 2 mit 2 Nageltaschen, Swinger und Messerscheide				
0031510	1	540 g	015119	59,65

Art.			EAN 4016671	EURO
74015				
Knieschoner "Picard" Knee pads Protecteur de genoux ZN 40159000 PG 2 für höchste Ansprüche, mit Gel-Einlage pure gel insert				
0074015-000	1	neu!	026283	33,15

Art.			EAN	EURO
70091				
Kunststoffkoffer Plastic tool box Coffret à outils en plastique ZN 39249090 PG 2 schwarz, mit Einsatz, ohne Inhalt, BTH 510 x 260 x 230 mm				
0070091-000	1	1800 g	015812	38,80

Art.			EAN	EURO
70092				
Blechkoffer Metal tool box Coffret à outils en métal ZN 42021190 PG 2 rot, mit Einsatz, ohne Inhalt, BTH 510 x 215 x 250 mm				
0070092-000	1		015829	100,35

24 Stiele und Keilhülsen Handles and Wedges Manches et Cales

Art.			EAN	EURO
370				
Keilhülse Round wedges Cales cylindriques ZN 73182400 PG 1 für festen und sicheren Sitz des Holzstiels im Hammerkopf for fastening wooden handles into hammerheads pour des manches de rechange				
0037000-1	100	100 - 200 g	009408	0,33
0037000-2	100	250 - 300 g	009415	0,36
0037000-3	50	400 - 500 g	009422	0,36
0037000-4	50	600 g	009439	0,39
0037000-5	50	800 g	009446	0,43
0037000-6	50	1000 g	009453	0,46
0037000-7	25	1250 g - 10 kg	009460	0,51

Art.			EAN 4016671	EURO
370a				
Keilhülsen-Sortiment Round wedges Cales cylindriques ZN 73182400 PG 1 je 50 Stück Gr. 1 - 5, je 25 Stück Gr. 6 - 7 for fastening wooden handles into hammerheads, set in carton pour des manches de rechange, jeux en carton				
0037010	1	Gr. 1 - 7	009477	105,60

Art.			EAN	EURO
99011 / 12				
Ersatzstiel Spare handles Manches individuels ZN 44170000 PG 1 doppelt geschweifte, lackierte Eschen- / Hickorstiele für No. 1, 16, 29, 85 for No. 1, 16, 29, 85 pour No. 1, 16, 29, 85				
0099011-0050	1	ES 250 mm	011005	1,50
0099011-0100	1	ES 260 mm	011012	1,50
0099011-0150	1	ES 270 mm	011029	1,50
0099011-0200	1	ES 280 mm	011036	1,60
0099011-0250	1	ES 290 mm	011043	1,95
0099011-0300	1	ES 300 mm	011050	2,10
0099011-0400	1	ES 310 mm	011067	2,20
0099011-0500	1	ES 320 mm	011074	2,25
0099011-0600	1	ES 330 mm	011081	2,35
0099011-0800	1	ES 350 mm	011098	2,60
0099011-1000	1	ES 360 mm	011104	2,65
0099011-1500	1	ES 380 mm	011111	3,20
0099011-2000	1	ES 400 mm	011128	3,55
0099012-0100	1	HS 260 mm	011142	3,15
0099012-0150	1	HS 270 mm	011159	3,15
0099012-0200	1	HS 280 mm	011166	3,15
0099012-0250	1	HS 290 mm	011173	3,80
0099012-0300	1	HS 300 mm	011180	3,80
0099012-0400	1	HS 310 mm	011197	4,15
0099012-0500	1	HS 320 mm	011203	4,80
0099012-0600	1	HS 330 mm	011210	5,15
0099012-0800	1	HS 350 mm	011227	5,40
0099012-1000	1	HS 360 mm	011234	6,55
0099012-1500	1	HS 380 mm	011241	7,05
0099012-2000	1	HS 400 mm	011258	7,85

Art. EAN 4016671 EURO

99021 / 22



Ersatzstiel
Spare handles
Manches individuels

ZN 44170000 PG 1
gerade, unlackierte Eschen- / Hickorstiele für
No. 2, 3, 4, 59
for No. 2, 3, 4, 59
pour No. 2, 3, 4, 59

0099021-03	1	ES 600 mm	018325	7,75
0099021-04	1	ES 700 mm	018332	10,40
0099021-05	1	ES 800 mm	018349	10,40
0099021-06	1	ES 800 mm	018356	10,40
0099021-08	1	ES 900 mm	018363	13,40
0099021-10	1	ES 900 mm	018370	13,40
0099022-03	1	HS 600 mm	018387	14,75
0099022-04	1	HS 700 mm	018394	14,75
0099022-05	1	HS 800 mm	018400	21,15
0099022-06	1	HS 800 mm	018417	21,15
0099022-08	1	HS 900 mm	018424	23,90
0099022-10	1	HS 900 mm	018431	23,90

99031 / 32



Ersatzstiel
Spare handles
Manches individuels

ZN 44170000 PG 1
doppelt geschweifte, lackierte Eschen- /
Hickorstiele für Fäustel (No. 4, 41, 59 1/2)
for No. 4, 41, 59 1/2
pour No. 4, 41, 59 1/2

0099031-1000	1	ES 260 mm	011265	2,30
0099031-1250	1	ES 270 mm	011272	2,65
0099031-1500	1	ES 280 mm	011289	2,65
0099031-2000	1	ES 300 mm	011296	3,40
0099032-1000	1	HS 260 mm	011302	5,10
0099032-1250	1	HS 270 mm	011319	5,25
0099032-1500	1	HS 280 mm	011326	5,85
0099032-2000	1	HS 300 mm	011333	6,75

Art. EAN 4016671 EURO

99041 / 42



Ersatzstiel
Spare handles
Manches individuels

ZN 44170000 PG 1
einfach geschweifte, lackierte Eschen- /
Hickorstiele für No. 9, 10, 165 - 187
for No. 9, 10, 165 - 187
pour No. 9, 10, 165 - 187

0099041-0100	1	ES 270-1/4	018547	1,95
0099041-0225	1	ES 290-1/2	018554	1,95
0099041-0340	1	ES 310-3/4	018561	2,10
0099041-0450	1	ES 325-1	018578	2,25
0099041-0500	1	ES 330-1 1/8	018585	2,25
0099041-0600	1	ES 350-1 1/4	018592	2,30
0099041-0700	1	ES 360-1 1/2	018608	2,30
0099041-0800	1	ES 370-1 3/4	018615	2,30
0099041-0900	1	ES 380-2	018622	2,70
0099042-0100	1	HS 270-1/4	018653	3,55
0099042-0225	1	HS 290-1/2	018660	3,55
0099042-0340	1	HS 310-3/4	018677	4,55
0099042-0450	1	HS 325-1	018684	4,90
0099042-0500	1	HS 330-1 1/8	018691	4,90
0099042-0600	1	HS 350-1 1/4	018707	5,55
0099042-0700	1	HS 360-1 1/2	018714	5,55
0099042-0800	1	HS 370-1 3/4	018721	5,55
0099042-0900	1	HS 380-2	018738	6,15

99051 / 52



Ersatzstiel
Spare handles
Manches individuels

ZN 44170000 PG 1
doppelt geschweifte, lackierte Eschen- /
Hickorstiele für Klauenhämmer (No. 92 - 94
1/2)
for No. 92 - 94 1/2
pour No. 92 - 94 1/2

0099051-23	1	ES 320 mm	018752	2,65
0099051-25	1	ES 330 mm	018769	2,65
0099051-27	1	ES 340 mm	018776	3,15
0099051-29	1	ES 350 mm	018783	3,70
0099052-23	1	HS 320 mm	018790	6,15
0099052-25	1	HS 330 mm	018806	6,15
0099052-27	1	HS 340 mm	018813	6,80
0099052-29	1	HS 350 mm	018820	7,45

99061 / 62



Ersatzstiel
Spare handles
Manches individuels

ZN 44170000 PG 1
doppelt geschweifte, lackierte Eschen- /
Hickorstiele für Ausbeulhämmer (No. 251/4
- 252/54)
for Bumping Hammers
pour marteaux à débosseler

0099061-300	1	ES	018844	3,45
0099061-320	1	ES	018851	3,70
0099062-300	1	HS	018868	4,95
0099062-320	1	HS	018875	5,35

Art.			EAN 4016671	EURO
99071				
			Eschenstiel Spare handles Manches individuels	
			ZN 44170000	PG 1
			oval, für Latthämmer No. 95a, 95b for No. 95a, 95b pour No. 95a, 95b	
0099071		1	018905	5,05

Art.			EAN 4016671	EURO
252/21 1/2				
			Ausbeulhammer Metal Shrinking and Bumping Hammer Marteau à débosseler	
			ZN 82052000	PG 1
2522191	6	ES	009828	31,35
2522192	6	HS	009835	34,05

25 Ausbeulwerkzeug Bumping Tools Outils de débosselage

Art.			EAN	EURO
251/4				
			Doppelter Ausbeulhammer Bumping Hammer double Marteau à débosseler double	
			ZN 82052000	PG 1
2510401	6	ES	009569	27,95
2510402	6	HS	009576	30,45

Art.			EAN	EURO
251/5				
			Einfacher Ausbeulhammer Bumping Hammer single Marteau à débosseler simple	
			ZN 82052000	PG 1
2510501	6	ES	009583	32,05
2510502	6	HS	009590	34,45

Art.			EAN	EURO
251/6				
			Doppelter Schlichthammer Planishing Hammer double Marteau à planer double	
			ZN 82052000	PG 1
2510601	6	ES	009606	27,95
2510602	6	HS	009613	30,45

Art.			EAN	EURO
251/6 1/2				
			Doppelter Schlichthammer Planishing Hammer double Marteau à planer double	
			ZN 82052000	PG 1
2510691	6	ES	009620	27,95
2510692	6	HS	009637	30,45

Art.			EAN	EURO
252/22				
			Spann-, Ausbeul- u. Schlichthammer Planishing Hammer Marteau à planer et à débosseler	
			ZN 82052000	PG 1
2522201	6	ES	009842	25,00
2522202	6	HS	009859	27,50

Art.			EAN	EURO
252/22 K				
			Spann-, Ausbeul- u. Schlichthammer Planishing Hammer Marteau à planer et à débosseler	
			ZN 82052000	PG 1
			runde Bahn charièrt round face checked face ronde gaufrée	
2522211	6	ES	009866	32,70
2522212	6	HS	009873	35,20

Art.			EAN	EURO
252/23				
			Spann-, Ausbeul- u. Schlichthammer Planishing Hammer Marteau à planer et à débosseler	
			ZN 82052000	PG 1
			kurze Form short pattern modèle court	
2522301	6	ES	009880	29,45
2522302	6	HS	009897	31,65

Art.			EAN	EURO
252/23 K				
			Spann-, Ausbeul- u. Schlichthammer Planishing Hammer Marteau à planer et à débosseler	
			ZN 82052000	PG 1
			kurze Form, runde Bahn charièrt short pattern, round face checked modèle court, face ronde gaufrée	
2522311	6	ES	009903	35,60
2522312	6	HS	009910	37,90

Art.			EAN 4016671	EURO
252/25				
			Ausbeulhammer Bumping Hammer Marteau à débosseler	
			ZN 82052000	PG 1
2522501	6	ES	009927	25,00
2522502	6	HS	009934	27,50

Art.			EAN 4016671	EURO
252/25 1/2				
			Ausbeulhammer Bumping Hammer Marteau à débosseler	
			ZN 82052000	PG 1
			lange Form long pattern modèle long	
2522591	6	ES	009941	34,85
2522592	6	HS	009958	37,35

Art.			EAN 4016671	EURO
252/26				
			Pickhammer Cross Pein and Finishing Hammer Marteau à plaqueur	
			ZN 82052000	PG 1
			mit Pinne avec panne	
2522601	6	ES	009965	34,40
2522602	6	HS	009972	36,25

Art.			EAN 4016671	EURO
252/27				
			Pickhammer Long Low spot Pick Hammer Marteau à débosseler et à boule combiné	
			ZN 82052000	PG 1
			mit Eichelspitze, 10 mm	
2522701	6	ES	009989	29,65
2522702	6	HS	009996	31,95

Art.			EAN 4016671	EURO
252/27 1/2				
			Pickhammer Pick Hammer Marteau à débosseler	
			ZN 82052000	PG 1
			kurze Form short pattern avec pointe, modèle court	
2522791	6	ES	010008	30,55
2522792	6	HS	010015	33,05

Art.			EAN 4016671	EURO
252/28				
			Schlicht- und Kugelhammer Ball End Hammer Marteau à planer et à boule combiné	
			ZN 82052000	PG 1
			Mit Kugeldurchmesser 18 mm combination long shank ball end and flat face	
2522801	6	ES	010022	29,65
2522802	6	HS	010039	32,10

Art.			EAN 4016671	EURO
252/28 1/2				
			Pickhammer Pick Hammer Marteau à débosseler	
			ZN 82052000	PG 1
			Spezialform Special pattern modèle spécial	
2522891	6	ES	010046	33,80
2522892	6	HS	010053	36,30

Art.			EAN 4016671	EURO
252/29				
			Ausbeulhammer Balanced Ding Hammer Marteau à débosseler	
			ZN 82052000	PG 1
2522901	6	ES	010060	29,90
2522902	6	HS	010077	32,20

Art.			EAN 4016671	EURO
252/30				
			Schlichthammer Planishing Hammer Marteau à planer	
			ZN 82052000	PG 1
2523001	6	ES	010084	27,50
2523002	6	HS	010091	30,35

Art.			EAN 4016671	EURO
252/45				
			Ausbeul-, Schlicht- u. Schweifhammer Planishing Hammer Marteau à planer et à débosseler	
			ZN 82052000	PG 1
			mit runder Querpinne 38 x 21 mm, käftige Bahn nach oben gekröpft 27 x 21 mm with round pein, square face curved à pène rond, face carrée courbée	
2524501	6	ES	010268	35,80
2524502	6	HS	010275	38,60

Art.			EAN 4016671	EURO
------	--	--	----------------	------

252/46



Ausbeul-, Schlicht- u. Schweifhammer
Planishing Hammer
Marteau à planer et à débosser

ZN 82052000 PG 1
mit senkrechter, runder Kreuzpinne 38 x 21 mm, kältige Bahn nach oben gekröpft 27 x 21 mm
with vertical round cross-pein, square face curved
avec pêne rond vertical, face carrée courbée

2524601	6	ES	010282	35,90
2524602	6	HS	010299	38,60

Art.			EAN 4016671	EURO
------	--	--	----------------	------

252/50



Spezial Ausbeul- u. Schlichthammer
Shrinking Hammer
Marteau à débosser et à planer

ZN 82052000 PG 1
mit großen, extra dünnen Bahnen, vierkant Bahn chariert
with extra wide and thin faces, square face checked
avec faces extra grandes et mices, face carrée gaufrée

2525001	6	ES	010367	46,15
2525002	6	HS	010374	49,25

Art.			EAN 4016671	EURO
------	--	--	----------------	------

252/47



Ausbeul- und Gummihammer
Bumping Hammer
Marteau à débosser

ZN 82052000 PG 1
mit auswechselbarem Gummiaufsatz, Durchm. 55 mm (Aufsatz = ZN 392690990)
with changeable rubber cap 55 mm
avec coup de caoutchouc 55 mm

2524702	1	HS	010305	58,25
2524710	1	Gummiaufsatz	010312	10,45

Art.			EAN 4016671	EURO
------	--	--	----------------	------

252/51



Spezial Ausbeul- u. Pinnhammer
Cross Pein and Finishing Hammer
Marteau à plaqueur

ZN 82052000 PG 1
mit großer, extra dünner Bahn
with extra wide and thin face
avec face extra grande et mices

2525101	6	ES	010381	33,60
2525102	6	HS	010398	36,10

Art.			EAN 4016671	EURO
------	--	--	----------------	------

252/48



Spann-, Ausbeul- u. Schlichthammer
Planishing Hammer
Marteau à planer et à débosser

ZN 82052000 PG 1
mit größeren Bahnen
with larger faces
avec faces plus grandes

2524801	6	ES	010329	33,65
2524802	6	HS	010336	36,60

Art.			EAN 4016671	EURO
------	--	--	----------------	------

252/52



Spezial Ausbeul- u. Pinnhammer
Cross Pein and Finishing Hammer
Marteau à plaqueur

ZN 82052000 PG 1
mit großer extra dünner Bahn und gerader Pinne
with extra wide and thin face, with straight pein
avec face extra grande et mices, avec panne droite

2525201	6	ES	010404	34,25
2525202	6	HS	010411	36,75

Art.			EAN 4016671	EURO
------	--	--	----------------	------

252/48 K



Spann-, Ausbeul- u. Schlichthammer
Planishing Hammer
Marteau à planer et à débosser

ZN 82052000 PG 1
mit größeren Bahnen, runde Bahn chariert
with larger faces, round face checked
avec faces plus grandes, face ronde gaufrée

2524811	6	ES	010343	42,95
2524812	6	HS	010350	46,05

Art.			EAN 4016671	EURO
------	--	--	----------------	------

252/53



Spezial Ausbeul- u. Schlichthammer
Shrinking Hammer
Marteau à débosser et à planer

ZN 82052000 PG 1
mit großen, extra dünnen Bahnen, 1 runde Bahn chariert
with extra wide and thin faces, 1 face checked
avec faces extra grandes et mices, 1 face gaufrée

2525301	6	ES	010428	42,95
2525302	6	HS	010435	46,05

Art.			EAN 4016671	EURO
252/54				
Ausbeul-Planierhammer Bumping and Planishing Hammer Marteau à débosseler et à planer				
			ZN 82052000	PG 1
			Bahn flach single end, flat face avec face plate	
2525401	6	ES	010442	37,20
2525402	6	HS	010459	39,70

252/54 K				
Ausbeul-Planierhammer Bumping and Planishing Hammer Marteau à débosseler et à planer				
			ZN 82052000	PG 1
			Bahn flach, chariert single end, with flat checked face avec face plate gaufrée	
2525411	6	ES	010466	37,70
2525412	6	HS	010473	40,20
2525461	6	ES fein chariert	019759	58,20

252/54 1/2				
Ausbeul-Planierhammer Bumping and Planishing Hammer Marteau à débosseler et à planer				
			ZN 82052000	PG 1
			Bahn gewölbt single end, with raised face avec face bombée	
2525491	6	ES	010480	37,20
2525492	6	HS	010497	39,70

251/1				
Großamboss Dolly Enclumette				
			ZN 82058000	PG 1
			large double	
2510100	1	1150 g	009538	58,75

251/2				
Kleinamboss Dolly Enclumette				
			ZN 82058000	PG 1
			small double	
2510200	1	920 g	009545	40,00

Art.			EAN 4016671	EURO
251/3				
Rundamboss Dolly Enclumette				
			ZN 82058000	PG 1
			round ronde	
2510300	1	930 g	009552	33,60

251/10				
General-Handamboss General Purpose Anvil Block Tas d'utilité générale				
			ZN 82058000	PG 1
2511000	1	1200 g	009699	50,20

252/11				
General-Handamboss General Purpose Anvil Block Tas d'utilité générale				
			ZN 82058000	PG 1
2521100	1	1400 g	009705	54,70

252/12				
Handamboss Heel Dolly Tas à main façon talon				
			ZN 82058000	PG 1
			Absatzform with round and flat faces	
2521200	1	1050 g	009712	35,65

252/13				
Handamboss Utility Dolly Tas pour carrossiers				
			ZN 82058000	PG 1
			für Kotflügelarbeiten convenient for every angle	
2521300	1	1200 g	009729	52,55

Art.			EAN 4016671	EURO
252/14				
Handamboss Utility Dolly Tas pour carrossiers				
ZN 82058000 PG 1 für Kotflügelarbeiten convenient for every angle				
2521400	1	550 g	009736	29,00

Art.			EAN 4016671	EURO
252/36				
Handamboss Anvil Block Tas de forme semelle				
ZN 82058000 PG 1 Sohlenform sole pattern				
2523600	1	950 g	010152	36,05

Art.			EAN 4016671	EURO
252/15				
Handfaust Roof Wedge Anvil Block Tas pour carnes				
ZN 82058000 PG 1 für Kanten				
2521500	1	950 g	009743	50,20

Art.			EAN 4016671	EURO
252/38				
Handamboss Utility Dolly Tas pour carrossiers				
ZN 82058000 PG 1 für Kotflügelarbeiten				
2523800	1	1100 g	010169	33,65

Art.			EAN 4016671	EURO
252/16				
Handfaust Anvil Block Tas pour carrossiers				
ZN 82058000 PG 1 Keilform				
2521600	1	900 g	009750	32,50

Art.			EAN 4016671	EURO
252/40				
Handfaust Anvil Block Tas forme de doigt du pied				
ZN 82058000 PG 1 Zehenform toe pattern				
2524000	1	760 g	010176	33,10

Art.			EAN 4016671	EURO
252/16 1/2				
Handamboss Utility Dolly Tas pour carrossiers				
ZN 82058000 PG 1 für Kotflügelarbeiten convenient for every angle				
2521690	1	1330 g	009767	59,90

Art.			EAN 4016671	EURO
252/40 S				
Handfaust Anvil Block Tas forme de doigt du pied				
ZN 82058000 PG 1 Zehenform, schwere Ausführung toe pattern				
2524040	1	1140 g	010183	35,60

Art.			EAN 4016671	EURO
252/17				
Handfaust Anvil Block Tas de forme "Mercedes"				
ZN 82058000 PG 1 Form "MERCEDES" "Mercedes" pattern				
2521700	1	1650 g	009774	52,90

Art.			EAN 4016671	EURO
252/40 K				
Handfaust Anvil Block Tas forme de doigt du pied				
ZN 82058000 PG 1 Zehenform, Bahn chariert toe pattern, face checked face gaufrée				
2524050	1	1100 g	010190	42,70

Art.			EAN 4016671	EURO
252/35				
Handamboss Anvil Block Tas de forme "Diabolo"				
ZN 82058000 PG 1 Form "Diabolo" "Diabolo" pattern				
2523500	1	750 g	010145	31,75

Art.			EAN 4016671	EURO
252/40 1/2				
Handamboss Utility Dolly Tas pour carrossiers				
ZN 82058000 PG 1 für Kotflügelarbeiten				
2524090	1	1050 g	010206	54,85

Art.			EAN 4016671	EURO
252/41				
Handfaust Anvil Block Tas à main				
ZN 82058000 PG 1 flach und gewölbt with flat and shaped faces avec faces planes et bombées				
2524100	1	2000 g	010213	56,95

Art.			EAN 4016671	EURO
252/56				
Handfaust Anvil Block Tas à main				
ZN 82058000 PG 1 leichte Beilform hatchet pattern forme hachette				
2525600	1	450 g	010510	17,95

Art.			EAN 4016671	EURO
252/41 1/2				
Handamboss Utility Dolly Tas pour carrossiers				
ZN 82058000 PG 1 für Kotflügelarbeiten				
2524190	1	700 g	010220	52,80

Art.			EAN 4016671	EURO
252/58				
Handfaust Utility Dolly Tas pour carrossiers				
ZN 82058000 PG 1 für Kotflügelarbeiten				
2525800	1	1100 g	010527	60,45

Art.			EAN 4016671	EURO
252/43				
Handfaust Anvil Block Tas à main				
ZN 82058000 PG 1 Beilform hatchet pattern façon hachette				
2524300	1	850 g	010244	32,05

Art.			EAN 4016671	EURO
252/59				
Handfaust Utility Dolly Tas pour carrossiers				
ZN 82058000 PG 1 für Kotflügelarbeiten				
2525900	1	920 g	010534	51,15

Art.			EAN 4016671	EURO
252/44				
Handfaust Anvil Block Tas à main				
ZN 82058000 PG 1 Beilform hatchet pattern façon hachette				
2524400	1	1600 g	010251	57,85

Art.			EAN 4016671	EURO
252/60				
Handfaust Anvil Block Tas à main				
ZN 82058000 PG 1 Arbeitsflächen flach und gewölbt with flat and shaped faces avec faces planes et bombées				
2526000	1	1600 g	010541	66,00

Art.			EAN 4016671	EURO
252/55				
Handfaust Anvil Block Tas à main				
ZN 82058000 PG 1 Spezialform special pattern modèle spécial				
2525500	1	1000 g	010503	50,60

Art.			EAN 4016671	EURO
251/8				
Biegeeisen Bending iron Fer à cintrer				
ZN 82055980 PG 1				
2510800	1	1000 g, 400 mm	009644	25,10

Art.			EAN 4016671	EURO
251/8 1/2				
Ausbeul-Schlageisen Beating iron for body repair Frappe de débousselage				
ZN 82055980 PG 1 Schlagfläche chariert, mit Plastikheft (slapper) face checked, with plastic handle face gaufrée a bord arrondi, avec manche plastique				
2510890	1	500 g	009651	60,30

Art.			EAN 4016671	EURO
252/18				
	Hebel- und Ausbeuleisen Inside Pry and Surfacing Spoon Levier pour carrossiers			
			ZN 82055980	PG 1
			kleine Form	
			small pattern	
			petit modèle	
2521800	1	550 g, 270 mm	009781	29,35

Art.			EAN 4016671	EURO
252/42				
	Hebel- und Ausbeuleisen Pry and Bumpind Spoon Levier pour carrossiers			
			ZN 82055980	PG 1
			große Form	
			long pattern	
			grand modèle	
2524200	1	1900 g, 440 mm	010237	61,85

Art.			EAN 4016671	EURO
252/18 1/2				
	Hebel- und Ausbeuleisen Inside Pry and Surfacing Spoon Levier pour carrossiers			
			ZN 82055980	PG 1
			kleine Form	
			small pattern	
			petit modèle	
2521890	1	850 g, 300 mm	009798	37,65

Art.			EAN 4016671	EURO
252/31				
	Rollkopf-Hebeleisen Pry Bar Barre à débosseler			
			ZN 82055980	PG 1
			verchromt, Durchm. 14 mm	
			chrome-plated	
			chromées	
2523100	1	480 g, 400 mm	010107	29,40

Art.			EAN 4016671	EURO
252/19				
	Hebel- und Ausbeuleisen Pry and Bumping Spoon Levier pour carrossiers			
			ZN 82055980	PG 1
			große Form	
			long pattern	
			grand modèle	
2521900	1	2200 g, 500 mm	009804	75,75

Art.			EAN 4016671	EURO
252/65				
	Universal-Hebeleisen Pry Bar Barre à débosseler			
			ZN 82055980	PG 1
			vernickelt	
			nickel plated	
			toutement nicklé	
2526500	1	650 g, 395 mm	010558	29,35

Art.			EAN 4016671	EURO
252/19 1/2				
	Hebel- und Ausbeuleisen Pry and Bumping Spoon Levier pour carrossiers			
			ZN 82055980	PG 1
2521990	1	950 g, 390 mm	009811	46,45

Art.			EAN 4016671	EURO
252/70				
	Reifenheber tire leaver licencié de pneu			
			ZN 82055980	PG 1
			gerade	
2527000-400	1		024661	9,60

Art.			EAN 4016671	EURO
252/19 1/2 K				
	Hebel- und Ausbeuleisen Pry and Bumping Spoon Levier pour carrossiers			
			ZN 82055980	PG 1
			Schlagfläche chariert	
			face checked	
			face gaufrée	
2521980	1	950 g, 390 mm	019766	59,90

Art.			EAN 4016671	EURO
252/71				
	Knieheber tire leaver licencié de pneu			
			ZN 82055980	PG 1
			for trucks	
			pour des camions	
2527100	1		024678	23,55

Art.			EAN 4016671	EURO
252/72				
	Schlitzmeißel cutting chisle			
			ZN 82055980	PG 1
			mit Handschutz, 230 x 26 x 7 mm	
			with hand guard	
2527200-230	1		026498	9,30

Art.			EAN 4016671	EURO
251/9 1/2				
Fräserfeilenhalter Milled curved tooth file Porte-limes				
ZN 84661038 PG 1 aus Leichtmetall, mit oder ohne Fräserfeilenblatt with holder of light metal en alliage léger, avec ou sans lime				
2510980	1	mit Feile	009668	56,95
2510990	1	ohne Feile	009682	29,40

251/9a				
Fräserfeilenblatt File Blade only Lime fraisée seule				
ZN 82031000 PG 1				
2510960	1	fein	025941	29,70
2510970	1	245 g, 355 mm	009675	27,60

252/32				
Kotflügelbiegezeuge Bending Plier Pince plieuse				
ZN 82032000 PG 1 Spannring beweglich for Mud-Guard-Repair pour garde-boue				
2523200	1	530 g, 280 mm	010114	39,50

252/33				
Bördelzange Flaging Plier Pince à débosseler				
ZN 82032000 PG 1				
2523300	1	590 g, 280 mm	010121	37,80

252/34				
Ausbeulzange Bumping Plier Pince à débosseler				
ZN 82032000 PG 1				
2523400	1	680 g, 295 mm	010138	29,90

252/39				
Abreißzange Breaking-off plier Pince pour détacher				
ZN 82032000 PG 1 (for bodies of cars) (pour carrosseries)				
2523900	1	780 g, 300 mm	019735	52,55

Art.			EAN 4016671	EURO
249				
Ausbeul-Werkzeug-Satz Bumping Tool Set Outils de débosselage				
ZN 99908200 PG 1 7-tlg. in sheet-iron boxes jeux en boîte de tôle				
0024900	1		010565	251,85

251				
Ausbeul-Werkzeug-Satz Bumping Tool Set Outils de débosselage				
ZN 99908200 PG 1 10-tlg. in sheet-iron boxes jeux en boîte de tôle				
0025100	1		010589	479,95

252				
Ausbeul-Werkzeug-Satz Bumping Tool Set Outils de débosselage				
ZN 99908200 PG 1 9-tlg. in sheet-iron boxes jeux en boîte de tôle				
0025200	1		010596	437,20

254				
Ausbeul-Werkzeug-Satz Bumping Tool Set Outils de débosselage				
ZN 99908200 PG 1 30-tlg. in sheet-iron boxes jeux en boîte de tôle				
0025400	1		010619	1.511,00

259				
Ausbeul-Werkzeug-Satz Bumping Tool Set Outils de débosselage				
ZN 82059000 PG 1 12-tlg. in sheet-iron boxes jeux en boîte de tôle				
0025900	1		010657	683,90

Art.			EAN 4016671	EURO
260				
			Ausbeul-Werkzeug-Satz Bumping Tool Set Outils de débosselage	
			ZN 99908200	PG 1
			25-tlg.	
			in sheet-iron boxes	
			jeux en boîte de tôle	
0026000		1	010664	1.170,50

26 Werbeartikel
promotional articles
Promotional

70126			Klingen-Klappmesser "Picard" Folding locking utility knife Couteaux pliants	
			ZN 82111000	PG 2
0070126-000		1	025613	10,65

70044			Lenkdrachen "Picard"	PG 2
0070044-000		1	025026	35,95

7910000			Baseball-Cap "Picard"	PG 2
			ZN 65059005	PG 2
7910000-001		1	026184	7,05

7910005			Schlüsselband "Picard"	PG 2
7910005-001		1	026191	4,70

Art.			EAN 4016671	EURO
7910010			Flaschenöffner-Hammer	
			ZN 82052000	PG 2
7910010-001		1	026207	9,95

7910015			Schreibblock "Picard"	PG 2
7910015-001		1	026214	11,95

7910020			T-Shirt "Picard"	PG 2	
			ZN 62052000	PG 2	
			Markenqualität, 100 % Baumwolle, Farbe: schwarz		
7910020-002		1	Größe M	026238	18,20
7910020-003		1	Größe L	026245	18,20
7910020-004		1	Größe XL	026252	18,20
7910020-005		1	Größe XXL	026269	18,20



Geltungsbereich

- Diese Allgemeinen Lieferungs- und Zahlungsbedingungen gelten, wenn die Vertragspartner sie schriftlich oder auf andere Weise vereinbart haben.
- Geschäftsbedingungen des Partners, die von uns nicht ausdrücklich anerkannt werden, haben keine Gültigkeit.

Allgemeine Bestimmungen

- Die Vertragspartner werden mündliche Vereinbarungen unverzüglich im einzelnen schriftlich bestätigen.
- Bestellungen werden erst mit unserer Auftragsbestätigung verbindlich.
- Die in Prospekten und Katalogen enthaltenen Angaben und Abbildungen sind branchenübliche Näherungswerte, es sei denn, dass sie von uns ausdrücklich als verbindlich bezeichnet wurden.

Langfrist- und Abrufverträge, Preisanpassung

- Unbefristete Verträge sind mit einer Frist von 6 Monaten kündbar.
- Tritt bei Langfristverträgen (Verträge mit einer Laufzeit von mehr als 12 Monaten und unbefristete Verträge) eine wesentliche Änderung der Lohn-, Material- oder Energiekosten ein, so ist jeder Vertragspartner berechtigt, eine angemessene Anpassung des Preises unter Berücksichtigung dieser Faktoren zu verlangen.
- Bei Lieferverträgen auf Abruf sind uns, wenn nichts anderes vereinbart ist, verbindliche Mengen mindestens 1 Monat vor dem Liefertermin durch Abruf mitzuteilen.
- Mehrkosten, die durch einen verspäteten Abruf oder nachträgliche Änderungen des Abrufs hinsichtlich Zeit oder Menge durch unseren Partner verursacht sind, gehen zu seinen Lasten; dabei ist unsere Kalkulation maßgebend.

Zeichnungen und Beschreibungen

- Stellt ein Vertragspartner dem anderen Zeichnungen oder technische Unterlagen über die zu liefernde Ware oder ihre Herstellung zur Verfügung, bleiben diese Eigentum des vorliegenden Vertragspartners.

Preise

- Unsere Preise verstehen sich in Euro ausschließlich Umsatzsteuer, Verpackung, Fracht, Porto und Versicherung.

Zahlungsbedingungen

- Alle Rechnungen sind innerhalb von Tagen, ab Rechnungsdatum zur Zahlung fällig. Bei Zahlung innerhalb von.... Tagen ab Rechnungsdatum werden Prozent Skonto gewährt, sofern der Partner nicht mit der Begleichung von Forderungen in Verzug ist.
- Haben wir unstreitig teilweise fehlerhafte Ware geliefert, ist unser Partner dennoch verpflichtet, die Zahlung für den fehlerfreien Anteil zu leisten; es sei denn, dass die Teillieferung für ihn kein Interesse hat. Im übrigen kann der Partner nur mit rechtskräftig festgestellten oder unbestrittenen Gegenansprüchen aufrechnen.
- Bei Zielüberschreitung sind wir berechtigt, Verzugszinsen in Höhe des Satzes in Rechnung zu stellen, den die Bank uns für Kontokorrentkredite berechnet, mindestens aber in Höhe von 3 Prozent über dem jeweiligen Diskontsatz der Deutschen Bundesbank, zu berechnen.
- Bei Zahlungsverzug können wir nach schriftlicher Mitteilung an den Partner die Erfüllung unserer Verpflichtungen bis zum Erhalt der Zahlungen einstellen.

Lieferung

- Sofern nichts anderes vereinbart ist, liefern wir "ab Werk". Maßgebend für die Einhaltung des Liefertermins oder der Lieferfrist ist die Meldung der Versand- bzw. Abholbereitschaft durch uns.
- Die Lieferfrist beginnt mit der Absendung unserer Auftragsbestätigung und verlängert sich angemessen, wenn die Voraussetzungen von Ziff. 54 vorliegen.
- Teillieferungen sind in zumutbarem Umfang zulässig. Sie werden gesondert in Rechnung gestellt.

Versand und Gefahrübergang

- Versandbereit gemeldete Ware ist vom Partner unverzüglich zu übernehmen. Anderenfalls sind wir berechtigt, sie nach eigener Wahl zu versenden oder auf Kosten und Gefahr des Partners zu lagern.
- Mangels besonderer Vereinbarung wählen wir das Transportmittel und den Transportweg.
- Mit der Übergabe an die Bahn, den Spediteur oder den Frachtführer bzw. mit Beginn der Lagerung, spätestens jedoch mit Verlassen des Werkes oder Lagers, geht die Gefahr auf den Partner über, und zwar auch, wenn wir die Anlieferung übernommen haben.

Lieferverzug

- Können wir absehen, dass die Ware nicht innerhalb der Lieferfrist geliefert werden kann, so wenden wir den Partner unverzüglich und schriftlich davon in Kenntnis setzen, ihm die Gründe hierfür mitteilen, sowie nach Möglichkeit den voraussichtlichen Lieferzeitpunkt nennen.
- Verzögert sich die Lieferung durch einen in Ziff. 54 aufgeführten Umstand oder durch ein Handeln oder Unterlassen des Partners, so wird eine den Umständen angemessene Verlängerung der Lieferfrist gewährt.

Eigentumsvorbehalt

- Wir behalten uns das Eigentum an der gelieferten Ware bis zur Erfüllung aller Forde-

rungen aus der Geschäftsverbindung mit dem Partner vor.

- Der Partner ist berechtigt, diese Waren im ordentlichen Geschäftsgang zu veräußern, solange er seinen Verpflichtungen aus der Geschäftsverbindung mit uns rechtzeitig nachkommt. Er darf jedoch die Vorbehaltsware weder verpfänden noch zur Sicherheit übereignen. Er ist verpflichtet, unsere Rechte beim kreditierten Weiterverkauf der Vorbehaltsware zu sichern.
- Bei Zahlungsverzug des Partners sind wir nach angemessener Nachfristsetzung berechtigt, auch ohne Rücktritt auf Kosten des Partners die Herausgabe

Gewährleistung

- Wir leisten Gewähr für einwandfreie Herstellung der von uns gelieferten Ware nach Maßgabe der vereinbarten technischen Liefervorschriften. Falls wir nach Zeichnungen, Spezifikationen, Mustern usw. unseres Partners zu liefern haben, übernimmt dieser das Risiko der Eignung für den vorgesehenen Verwendungszweck. Entscheidend für den vertragsgemäßen Zustand der Ware ist der Zeitpunkt des Gefahrübergangs.
- Für Mängel, die durch ungeeignete oder unsachgemäße Verwendung, fehlerhafte Montage bzw. Inbetriebsetzung durch den Partner oder Dritte, übliche Abnutzung, fehlerhafte oder nachlässige Behandlung entstehen, wird ebenso wenig Gewähr geleistet wie für die Folgen unsachgemäßer und ohne unsere Einwilligung vorgenommener Änderungen oder Instandsetzungsarbeiten des Partners oder Dritter.
- Die Gewährleistungsfrist richtet sich, soweit nichts anderes vereinbart ist, nach dem Gesetz.
- Offene Mängel hat der Partner unverzüglich nach Eingang der Ware am Bestimmungsort, verdeckte Mängel unverzüglich - jedoch spätestens innerhalb von 6 Monaten nach Gefahrübergang - nach Entdeckung des Fehlers schriftlich zu rügen.
- Wurde eine Abnahme der Ware oder eine Erstmusterprüfung vereinbart, ist die Rüge von Mängeln ausgeschlossen, die der Partner bei sorgfältiger Abnahme oder Erstmusterprüfung hätte feststellen können.
- Uns ist Gelegenheit zu geben, den gerügten Mangel festzustellen. Beanstandete Ware ist auf Verlangen unverzüglich an uns zurück zu senden wir übernehmen die Transportkosten, wenn die Mängelrüge berechtigt ist. Wenn der Partner diesen Verpflichtungen nicht nachkommt oder ohne unsere Zustimmung Änderungen an der bereits beanstandeten Ware vornimmt, verliert er etwaige Gewährleistungsansprüche.
- Es gilt der gesetzliche Wandlungs- und Minderungsanspruch.

Sonstige Ansprüche, Haftung

- Soweit sich nachstehend nichts anderes ergibt, sind sonstige und weitergehende Ansprüche des Partners gegen uns ausgeschlossen. Dies gilt insbesondere für Schadenersatzansprüche aus Verzug, aus Unmöglichkeit der Leistung, aus schuldhafter Verletzung vertraglicher Nebenpflichten aus Verschulden bei Vertragsabschluss aus unerlaubter Handlung. Wir haften deshalb nicht für Schäden, die nicht an der gelieferten Ware selbst entstanden sind, Vor allem haften wir nicht für entgangenen Gewinn oder sonstige Vermögensschäden des Partners.
- Soweit unsere Haftung ausgeschlossen oder beschränkt ist, gilt dies auch für die persönliche Haftung unserer Angestellten, Arbeitnehmer, Mitarbeiter, gesetzlichen Vertreter und Erfüllungsgehilfen.
- Die gesetzlichen Regelungen zur Beweislast bleiben hiervon unberührt.

Höhere Gewalt

- Höhere Gewalt, Arbeitskämpfe, Unruhen, behördliche Maßnahmen, Ausbleiben von Zulieferungen unserer Lieferanten und sonstige unvorhersehbare, unabwendbare und schwerwiegende Ereignisse befreien die Vertragspartner für die Dauer der Störung und im Umfang ihrer Wirkung von den Leistungspflichten. Dies gilt auch, wenn diese Ereignisse zu einem Zeitpunkt eintreten, in dem sich der betroffene Vertragspartner in Verzug befindet. Die Vertragspartner sind verpflichtet, im Rahmen des Zumutbaren unverzüglich die erforderlichen Informationen zu geben und ihre Verpflichtungen den veränderten Verhältnissen nach Treu und Glauben anzupassen.

Erfüllungsort, Gerichtsstand und anwendbares Recht

- Sofern sich aus der Auftragsbestätigung nichts anderes ergibt, ist unser Geschäftssitz Erfüllungsort.
- Für alle Rechtsstreitigkeiten, auch im Rahmen eines Wechsel und Scheckprozesses, ist unser Geschäftssitz Gerichtsstand, wenn der Partner Vollkaufmann, eine juristische Person des öffentlichen Rechts oder ein öffentlich-rechtliches Sondervermögen ist. Wir sind auch berechtigt, am Sitz des Partners zu klagen.
- Auf die Vertragsbeziehung ist ausschließlich das Recht der Bundesrepublik Deutschland anzuwenden.
- Die Anwendung des Übereinkommens der Vereinten Nationen vom 11. April 1980 über Verträge über den Warenkauf (CISG - "Wiener Kaufrecht") ist ausgeschlossen.

Our General Terms and Conditions of Supply and Payment in the English language will, of course, be sent to you on request.

Nos conditions générales de vente en langue française vous seront volontairement transmises sur demande.